



MP3/WMA CD Receiver

CDA-9856

MP3



- **OWNER'S MANUAL**
Please read before using this equipment.
- **MODE D'EMPLOI**
Veuillez lire avant d'utiliser cet appareil.
- **MANUAL DE OPERACIÓN**
Léalo antes de utilizar este equipo.

ALPINE ELECTRONICS MARKETING, INC.
1-1-8 Nishi Gotanda,
Shinagawa-ku,
Tokyo 141-0031, Japan
Phone 03-5496-8231

ALPINE ELECTRONICS OF AMERICA, INC.
19145 Gramercy Place, Torrance,
California 90501, U.S.A.
Phone 1-800-ALPINE-1 (1-800-257-4631)

ALPINE ELECTRONICS OF CANADA, INC.
777 Supertest Road, Toronto,
Ontario M3J 2M9, Canada
Phone 1-800-ALPINE-1 (1-800-257-4631)

ALPINE ELECTRONICS OF AUSTRALIA PTY. LTD.
161-165 Princes Highway, Hallam
Victoria 3803, Australia
Phone 03-8787-1200

ALPINE ELECTRONICS GmbH
Frankfurter Ring 117, 80807 München, Germany
Phone 089-32 42 640

ALPINE ELECTRONICS OF U.K. LTD.
Alpine House
Fletchamstead Highway, Coventry CV4 9TW, U.K.
Phone 0870-33 33 763

ALPINE ELECTRONICS FRANCE S.A.R.L.
(RCS PONTOISE B 338 101 280)
98, Rue de la Belle Etoile, Z.I. Paris Nord II,
B.P. 50016, 95945 Roissy Charles de Gaulle
Cedex, France
Phone 01-48638989

ALPINE ITALIA S.p.A.
Viale C. Colombo 8, 20090 Trezzano
Sul Naviglio (MI), Italy
Phone 02-484781

ALPINE ELECTRONICS DE ESPAÑA, S.A.
Portal de Gamarra 36, Pabellón, 32
01013 Vitoria (Alava)-APDO 133, Spain
Phone 945-283588

ALPINE ELECTRONICS (BENELUX) GmbH
Leuvensesteenweg 510-B6,
1930 Zaventem, Belgium
Phone 02-725-13 15

EN

FR

ES

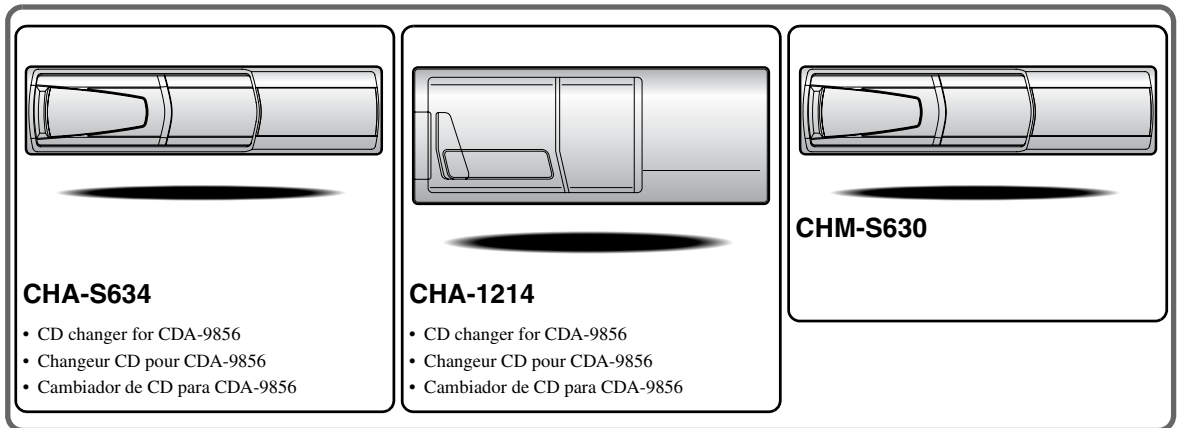

Alpine CD Changers Give You More!

More musical selections, more versatility, more convenience.

The CHA-S634 is a high-performance 6-disc changer with a new M DAC, CD-R/RW PLAY BACK, MP3 PLAY BACK and CD TEXT. The CHA-1214 Ai-NET model holds 12 discs, and the CHM-S630 M-Bus model is a super-compact 6-disc changer with a CD-R/RW PLAY BACK.

Changeurs de CD Alpine : vous avez le choix!

Plus de sélections musicales, plus de souplesse, plus de confort.

Le modèle CHA-S634 est un changeur 6 disques ultra performant équipé des nouvelles fonctions M DAC, CD-R/RW PLAY BACK, MP3 PLAY BACK et CD TEXT. Le modèle CHA-1214 Ai-NET contient 12 disques. Le modèle CHM-S630 M-Bus est un changeur 6 disques super compact doté de la fonction CD-R/RW PLAY BACK.

¡Los cambiadores Alpine de CD le ofrecen más!

Más selecciones musicales, más versatilidad y más ventajas.

CHA-S634 es un cambiador de seis discos de alto rendimiento con nuevo M DAC, CD-R/RW PLAY BACK, MP3 PLAY BACK y CD TEXT. El modelo CHA-1214 Ai-NET alberga 12 discos y el modelo CHM-S630 M-Bus es un cambiador de seis discos de tamaño reducido con un CD-R/RW PLAY BACK.

Contents

Operating Instructions

WARNING

WARNING	3
CAUTION	3
PRECAUTIONS	3

Getting Started

Turning Power On and Off	6
Detaching and Attaching the Front Panel	6
Initial System Start-Up	7
Adjusting Volume	7
Lowering Volume Quickly	7
Setting Time	7

Radio

Listening to Radio	8
Manual Storing of Station Presets	8
Automatic Memory of Station Presets	8
Tuning to Preset Stations	8
Frequency Search Function	9
Switching the HD Radio™ signal	9

CD/MP3/WMA

Playback	9
Repeat Play	10
M.I.X. (Random Play)	10
Searching from CD Text	11
File/Folder Name Search (concerning MP3/WMA)	11
Quick Search	11
About MP3/WMA	11

Sound Setting

Adjusting Bass/Treble/Balance (Between Left and Right)/Fader (Between Front and Rear)/ Defeat	13
Setting the Bass Control	13
Setting the Treble Control	14
Setting the BBE Mode	14

Other Functions

Displaying the Text	15
Displaying Time	16

SETUP

Sound Customizing

Subwoofer On and Off	17
Setting the Subwoofer System	17

Visual Customizing

Dimmer Control	17
Scroll Type Setting	17
Scroll Setting (TEXT SCROLL)	17
HD Radio Station Call Setting	17
Demonstration	17

MP3/WMA

Playing MP3/WMA Data (PLAY MODE)	18
--	----

External Device

Turning Mute Mode On/Off (INT MUTE)	18
Setting the AUX Mode (V-Link)	18
Setting the External Digital Input (DIGITAL AUX)	18
Connecting to an External Amplifier	18

SAT Radio Receiver (Optional)

Receiving Channels with the SAT Radio Receiver (Optional)	19
Checking the SAT Radio ID Number	19
Setting the Tuning Method	19
Storing Channel Presets	20
Receiving Stored Channels	20
Category/Channel Search Function	20
Quick Search Function	20
Receiving Weather or Traffic information from SAT Radio	20
Changing the Display	21
Setting the Auxiliary Data Field Display	21

iPod™ (Optional)

Playback	22
Searching for a desired Song	22
Searching by Playlist	22
Searching by artist name	22
Searching by album name	23
Searching by song name	23
Select Playlist/Artist/Album	23
Quick Search	23
Random Play Shuffle (M.I.X.)	24
Repeat Play	24
Displaying the Text	24

Changer (Optional)

Controlling CD Changer (Optional)	25
Playing MP3 Files with the CD Changer (Optional)	25
Multi-Changer Selection (Optional)	25

Information

In Case of Difficulty	26
Specifications	28

Installation and Connections

Warning	29
Caution	29
Precautions	29
Installation	30
Connections	32

LIMITED WARRANTY

Operating Instructions

WARNING



WARNING

This symbol means important instructions. Failure to heed them can result in serious injury or death.

DO NOT OPERATE ANY FUNCTION THAT TAKES YOUR ATTENTION AWAY FROM SAFELY DRIVING YOUR VEHICLE.

Any function that requires your prolonged attention should only be performed after coming to a complete stop. Always stop the vehicle in a safe location before performing these functions. Failure to do so may result in an accident.

KEEP THE VOLUME AT A LEVEL WHERE YOU CAN STILL HEAR OUTSIDE NOISE WHILE DRIVING.

Failure to do so may result in an accident.

MINIMIZE DISPLAY VIEWING WHILE DRIVING.

Viewing the display may distract the driver from looking ahead of the vehicle and cause an accident.

DO NOT DISASSEMBLE OR ALTER.

Doing so may result in an accident, fire or electric shock.

USE ONLY IN CARS WITH A 12 VOLT NEGATIVE GROUND.

(Check with your dealer if you are not sure.) Failure to do so may result in fire, etc.

KEEP SMALL OBJECTS SUCH AS BATTERIES OUT OF THE REACH OF CHILDREN.

Swallowing them may result in serious injury. If swallowed, consult a physician immediately.

USE THE CORRECT AMPERE RATING WHEN REPLACING FUSES.

Failure to do so may result in fire or electric shock.

DO NOT BLOCK VENTS OR RADIATOR PANELS.

Doing so may cause heat to build up inside and may result in fire.

USE THIS PRODUCT FOR MOBILE 12V APPLICATIONS.

Use for other than its designed application may result in fire, electric shock or other injury.

DO NOT PLACE HANDS, FINGERS OR FOREIGN OBJECTS IN INSERTION SLOTS OR GAPS.

Doing so may result in personal injury or damage to the product.



CAUTION

This symbol means important instructions. Failure to heed them can result in injury or material property damage.

HALT USE IMMEDIATELY IF A PROBLEM APPEARS.

Failure to do so may cause personal injury or damage to the product. Return it to your authorized Alpine dealer or the nearest Alpine Service Center for repairing.



PRECAUTIONS

Product Cleaning

Use a soft dry cloth for periodic cleaning of the product. For more severe stains, please dampen the cloth with water only. Anything else has the chance of dissolving the paint or damaging the plastic.

Temperature

Be sure the temperature inside the vehicle is between +60°C (+140°F) and -10°C (+14°F) before turning your unit on.

Moisture Condensation

You may notice the CD playback sound wavering due to condensation. If this happens, remove the disc from the player and wait about an hour for the moisture to evaporate.

Damaged Disc

Do not attempt to play cracked, warped, or damaged discs. Playing a bad disc could severely damage the playback mechanism.

Maintenance

If you have problems, do not attempt to repair the unit yourself. Return it to your Alpine dealer or the nearest Alpine Service Station for servicing.

Never Attempt the Following

Do not grip or pull out the disc while it is being pulled back into the player by the automatic reloading mechanism.
Do not attempt to insert a disc into the unit when the unit power is off.

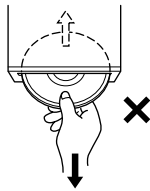

Inserting Discs

Your player accepts only one disc at a time for playback. Do not attempt to load more than one disc.
Make sure the label side is facing up when you insert the disc. "ERROR" will be displayed on your player if you insert a disc incorrectly. If "ERROR" continues to be displayed even though the disc has been inserted correctly, push the RESET switch with a pointed object such as a ballpoint pen.
Playing a disc while driving on a very bumpy road may result in skips, but this will not scratch the disc or damage the player.

New Discs

To prevent the CD from jamming, "ERROR" is displayed if discs with irregular surfaces are inserted or if discs are inserted incorrectly. When a new disc is ejected immediately after initial loading, use your finger to feel around the inside of the center hole and outside edge of the disc. If you feel any small bumps or irregularities, this could inhibit proper loading of the disc. To remove the bumps, rub the inside edge of the hole and outside edge of the disc with a ballpoint pen or other such instrument, then insert the disc again.

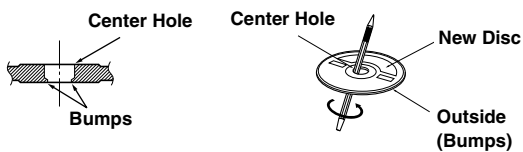

Irregular Shaped Discs

Be sure to use round shape discs only for this unit and never use any special shape discs.
Use of special shape discs may cause damage to the mechanism.

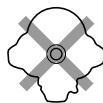

Installation Location

Make sure the CDA-9856 will not be installed in a location subjected to:

- Direct sun and heat
- High humidity and water
- Excessive dust
- Excessive vibrations

Correct Handling

Do not drop the disc while handling. Hold the disc so you will not leave fingerprints on the surface. Do not affix tape, paper, or gummed labels to the disc. Do not write on the disc.

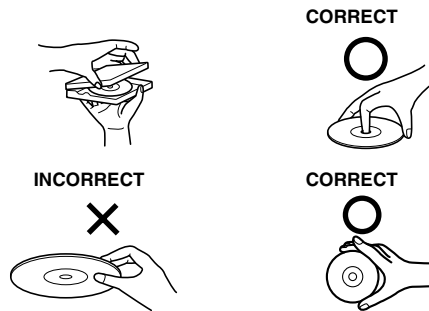

Disc Cleaning

Fingerprints, dust, or soil on the surface of the disc could cause the CD player to skip. For routine cleaning, wipe the playing surface with a clean, soft cloth from the centre of the disc to the outer edge. If the surface is heavily soiled, dampen a clean, soft cloth in a solution of mild neutral detergent before cleaning the disc.



Disc Accessories

There are various accessories available on the market for protecting the disc surface and improving sound quality. However, most of them will influence the thickness and/or diameter of the disc. Using such accessories can cause the disc to be out of standard specifications and may create operational problems. We recommend not using these accessories on discs played in Alpine CD players.

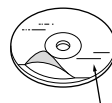

Transparent Sheet

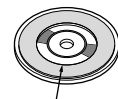

Disc Stabilizer

On handling Compact Discs (CD/CD-R/CD-RW)

- Do not touch the surface.
- Do not expose the disc to direct sunlight.
- Do not affix stickers or labels.
- Clean the disc when it is dusty.
- Make sure that there are no bumps around the disc.
- Do not use commercially available disc accessories.

Do not leave the disc in the car or the unit for a long time. Never expose the disc to direct sunlight. Heat and humidity may damage the CD and you may not be able to play it again.

To customers using CD-R/CD-RW

- If a CD-R/CD-RW cannot be played back, make sure the last recording session was closed (finalized).
- Finalize the CD-R/CD-RW if necessary, and attempt playback again.

About media that can be played

Use only compact discs with the label side showing the CD logo marks below.



If you use unspecified compact discs, correct performance cannot be guaranteed.

You can play CD-Rs (CD-Recordable)/CD-RWs (CD-ReWritable) which have been recorded only on audio devices. You can also play CD-Rs/CD-RWs containing MP3/WMA formatted audio files.

- Some of the following CDs may not play on this unit:
Flawed CDs, CDs with fingerprints, CDs exposed to extreme temperatures or sunlight (e.g., left in the car or this unit), CDs recorded under unstable conditions, CDs on which a recording failed or a re-recording was attempted, copy-protected CDs which do not conform to the audio CD industry standard.
- Use discs with MP3/WMA files written in a format compatible with this unit. For details, see pages 11-12.
- ROM data other than audio files contained in a disc will not produce sound when played back.

-
- *Windows Media and the Windows logo are trademarks, or registered trademarks of Microsoft Corporation in the United States and/or other countries.*
 - *Apple and the Apple logo are trademarks of Apple Computer, Inc., registered in the U.S. and other countries. iPod and iPod mini are trademarks of Apple Computer, Inc.*
 - *“MPEG Layer-3 audio coding technology licensed from Fraunhofer IIS and Thomson.”*
 - *“Supply of this product only conveys a license for private, non-commercial use and does not convey a license nor imply any right to use this product in any commercial (i.e. revenue-generation) real time broadcasting (terrestrial, satellite, cable and/or any other media), broadcasting/streaming via internet, intranets and/or other networks or in other electronic content distribution systems, such as pay-audio or audio-on-demand applications. An independent license for such use is required. For details, please visit <http://www.mp3licensing.com>.”*

Getting Started

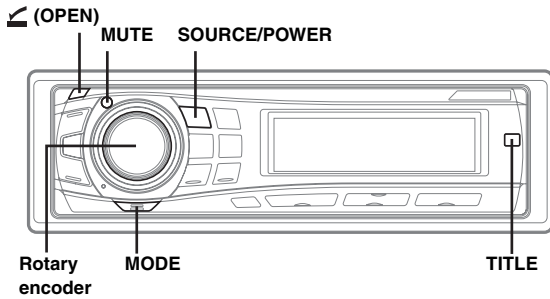

About the alphanumeric display of this unit

- All English lower case characters are displayed as upper case on this unit.
- The alphanumeric display in the following table shows alphanumeric characters/numbers that may be difficult to distinguish.

Alphanumeric	0	2	5	6	8	A	B	D
Display	0	2	5	6	8	A	B	D
Alphanumeric	G	H	K	M	Q	R	S	Z
Display	G	H	K	M	Q	R	S	Z

Turning Power On and Off

Press **SOURCE/POWER** to turn on the unit.

- The unit can be turned on by pressing any other button except **TITLE**, **Rotary encoder** and **(OPEN)**.

Press and hold **SOURCE/POWER** for at least 2 seconds to turn off the unit.

- The first time power is turned on, the volume will start from level 12.

Detaching and Attaching the Front Panel

Be sure to push the **Rotary encoder** inside the unit before opening the front panel so that the front panel will open completely, otherwise it may be damaged.

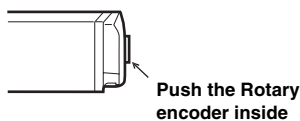

When you push the **Rotary encoder** again, it pops back out.

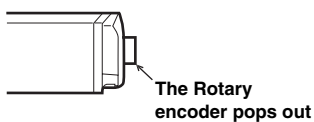

Detaching

- Turn off the unit power.
- Press **(OPEN)** to open the front panel.

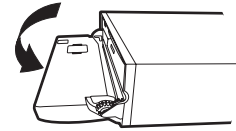

To close the front panel, press the left side until it locks as shown in the figure below.

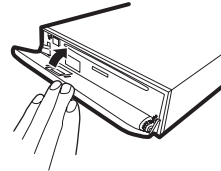

- Grasp the front panel firmly, slide to the left **1**, then pull **2** to remove.

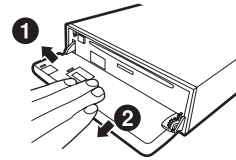

- The front panel may become hot in normal usage (especially the connector terminals on the back of the front panel.) This is not a malfunction.
- To protect the front panel, place it in the supplied carrying case.
- When detaching the front panel, do not apply excessive force as it may result in malfunction.
- Do not leave the front panel open, or drive the car with the panel open as it may result in accident or malfunction.

Attaching

- Insert the right side of the front panel into the main unit. Align the groove on the front panel with the projections on the main unit.
- Push the left side of the front panel until it locks firmly into the main unit.

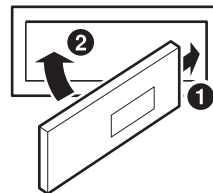

- Before attaching the front panel, make sure that there is no dirt or dust on the connector terminals and no foreign object between the front panel and the main unit.
- Attach the front panel carefully, holding the sides of the front panel to avoid pushing buttons by mistake.

Initial System Start-Up

Be sure to press the RESET switch when using the unit for the first time, after changing the car battery, etc.

- 1 Turn off the unit power.
- 2 Press \triangleleft (OPEN) to open the front panel, then remove it.
- 3 Press **RESET** with a ballpoint pen or similar pointed object.

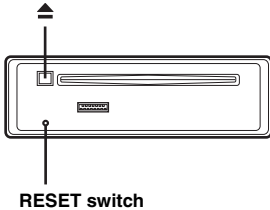

- **Controllable with Remote Control**
This unit can be controlled with an optional Alpine remote control. For details, consult your Alpine dealer.
- Point the optional remote control transmitter at the remote control sensor

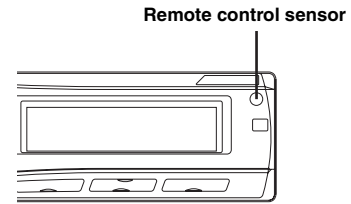

Adjusting Volume

Turn the **Rotary encoder** until the desired sound is obtained.

Lowering Volume Quickly

Activating the Audio Mute function will instantly lower the volume level by 20 dB.

Press **MUTE** to activate the **MUTE mode**.

The audio level will decrease by about 20 dB.

Pressing **MUTE** again will bring the audio back to its previous level.

Setting Time

- 1 Press **TITLE** repeatedly until the time is displayed.
For details, see "Displaying the Text" (page 15)
 - 2 Press and hold **TITLE** for at least 2 seconds while the time is displayed.
The time indication will blink.
 - 3 Turn the **Rotary encoder** to adjust the hours while the time indication is blinking.
 - 4 When the hour has been adjusted, press **MODE**.
 - 5 Turn the **Rotary encoder** to adjust the minutes while the time indication is blinking.
The time is automatically set 5 seconds after the minute adjustment. The time can also be manually set by pressing **TITLE**.
- To synchronize the clock to another clock/watch or radio time announcement, press and hold **MODE** for at least 2 seconds after setting the "hour." Minutes will reset to 00. If the display shows over "30" minutes when you do this, the time will advance one hour.

Radio

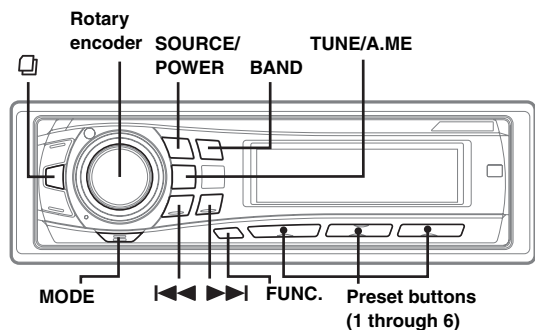

This unit cannot receive HD Radio™ signals (digital terrestrial radio). In order to activate the digital radio functions described below, an optional HD Radio Tuner module must be connected through the Ai-Net bus.

HD Radio™ Technology Manufactured Under License From iBiquity Digital Corporation. iBiquity Digital and the HD Radio and HD Symbols are trademarks of iBiquity Digital Corporation. U.S. and Foreign Patents.

Listening to Radio

- 1 Press **SOURCE/POWER** until a radio frequency appears on the display.
- 2 Press **BAND** repeatedly until the desired radio band is displayed.

F1 (FM1) → F2 (FM2) → AM → F1 (FM1)

- 3 Press **TUNE/A.ME** to select the tuning mode.

DX SEEK (Distance mode) → SEEK (Local mode) → OFF (Manual mode) → DX SEEK

- The initial mode is Distance mode.

Distance mode:

Both strong and weak stations will be automatically tuned in (Automatic Seek Tuning).

Local mode:

Only strong stations will be automatically tuned in (Automatic Seek Tuning).

Manual mode:

The frequency is manually tuned in steps (Manual tuning).

- 4 Press **◀◀** or **▶▶** to tune in the desired station. Holding down **◀◀** or **▶▶** will change the frequency continuously.
- The “DIGITAL” indicator appears on the display when a digital radio station which contains both audio and text information, is received.

Manual Storing of Station Presets

- 1 Select the radio band and tune in a desired radio station you wish to store in the preset memory.
 - 2 Press and hold, for at least 2 seconds, any one of the **preset buttons (1 through 6)** into which you wish to store the station.
The selected station is stored.
The display shows the band, preset number and station frequency memorized.
- A total of 18 stations can be stored in the preset memory (6 stations for each band; FM1, FM2 and AM).
 - If you store a station in a preset memory which already has a station, the current station will be cleared and replaced with the new station.

Automatic Memory of Station Presets

- 1 Press **BAND** repeatedly until the desired radio band is displayed.
 - 2 Press and hold **TUNE/A.ME** for at least 2 seconds.
The frequency on the display continues to change while the automatic memory is in progress. The tuner will automatically seek and store 6 strong stations in the selected band. They will be stored into buttons 1 to 6 in order of signal strength.
When the automatic memory has been completed, the tuner goes to the station stored in preset location No. 1.
- If no stations are stored, the tuner will return to the original station you were listening to before the auto memory procedure began.

Tuning to Preset Stations

- 1 Press **BAND** repeatedly until the desired band is displayed.
- 2 Press any one of the **station preset buttons (1 through 6)** that has your desired radio station in memory.
The display shows the band, preset number and frequency of the station selected.

Frequency Search Function

You can search for a radio station by its frequency.

- 1 Press and hold  for at least 2 seconds in Radio mode to activate Frequency Search mode.
- 2 Turn the **Rotary encoder** to select the desired frequency.

Only when the Radio mode is active*

* Operation is not required during HD Radio reception.

- 3 Press **MODE** to receive the selected frequency.
- Press and hold  for at least 2 seconds in the search mode to cancel. Or the search mode will be canceled when an operation has not been performed in 10 seconds.

Switching the HD Radio™ signal

HD Radio™ can be received if the HD Radio TUNER MODULE (TUA-T500HD) is connected. While receiving HD Radio, the unit can automatically switch between the analog and digital signal. You can also switch to the analog signal exclusively.

- 1 When receiving HD Radio, press **FUNC.** to select on.
The currently received status is displayed.
 - 2 Press **preset 1** to switch the receiving signal.
DIG/ANA MODE ↔ ANALOG ONLY

DIG/ANA MODE: Automatically switches between digital and analog signal
ANALOG ONLY: Receives analog signal only
 - 3 Turn off the “**FUNC.**” indicator by pressing **FUNC.**
- Select mode will be canceled when an operation has not been performed in 10 seconds.

CD/MP3/WMA

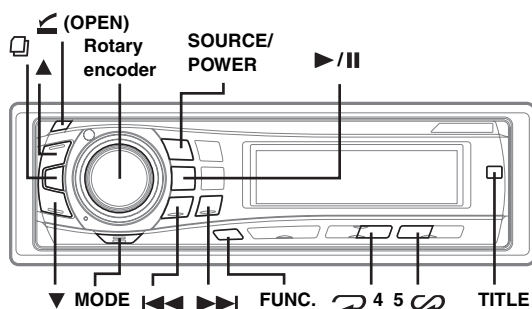

Playback



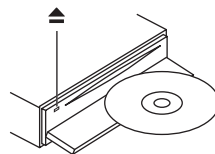











- 1 Press  (**OPEN**).
The front panel will open.
- 2 Insert a disc with the label side facing up.
The disc will be pulled into the unit automatically.



Close the front panel manually.
When a disc is already inserted, press **SOURCE/POWER** to switch to the CD mode.

TUNER → XM RADIO/SIRIUS*¹ → DISC → IPOD*² → CHANGER*³ → TUNER

- *¹ Only when XM Radio or Sirius Radio is connected.
- *² Only when the iPod is connected.
- *³ Only when the CD changer is connected.

- 3 While playing back MP3/WMA, press  or  to select the desired folder.
Pressing and holding  or  will change folders continuously.
- 4 Press  or  to select the desired track (file).
Returning to the beginning of the current track (file):
Press .
Fast backward:
Press and hold .
Advancing to the beginning of the next track (file):
Press .
Fast forward:
Press and hold .
- 5 To pause playback, press . Pressing  again will resume playback.
- 6 After pressing  (**OPEN**) to open the front panel, press  to eject the disc.

- Do not remove a CD during its eject cycle. Do not load more than one disc at a time. A malfunction may result from doing either.

- If the CD does not eject, press and hold **▲** for at least 2 seconds.
- The CD-player can play discs containing audio data, MP3 data and WMA data.
- A WMA format file that is protected by DRM (Digital Rights Management) cannot be played back on this unit.
- The track display for MP3/WMA data playback is the file numbers recorded on the disc.
- The playback time may not be correctly displayed when a VBR (Variable Bit Rate) recorded file is played back.

MP3/WMA Play Display

The folder number and file number will be displayed as described below.

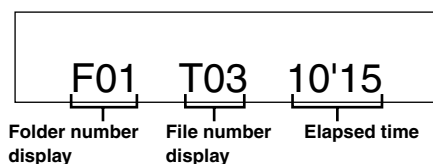

- Press **TITLE** to switch the display. Please see "Displaying the Text" (page 15) for information about display switching.
- If the folder or file number is three digits, "F" or "T" is not displayed.

Repeat Play

Press **↶ 4** to play back repeatedly the track being played.

The track (file) will be played repeatedly.

Press **↶ 4** again and select off to deactivate repeat play.

CD mode :

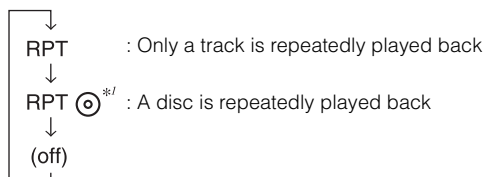

^{*1} When a CD changer is connected

- If **REPEAT** is set to ON during **M.I.X. (M.I.X. ONE)** play in CD changer mode, **M.I.X.** will apply to the current disc only.

MP3/WMA mode :

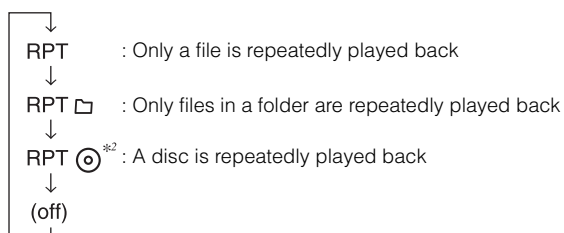

^{*2} When an MP3 compatible CD changer is connected

- If a 6-disc CD changer or an MP3 compatible CD changer is connected:
In CD changer mode, press **FUNC.** to illuminate the "**•FUNC•**" indicator, and go to the step above within 10 seconds.
- If a 12-disc CD changer is connected:
In CD changer mode, press **FUNC.** twice to illuminate the "**•FUNC•**" indicator, and go to the step above within 10 seconds.

M.I.X. (Random Play)

Press **5** **∞** in the play or pause mode.

The tracks (files) on the disc will be played back in random sequence.

To cancel M.I.X. play, press **5** **∞** again.

Internal CD mode :

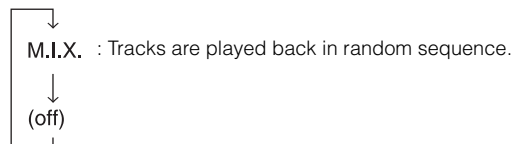

CD Changer mode :

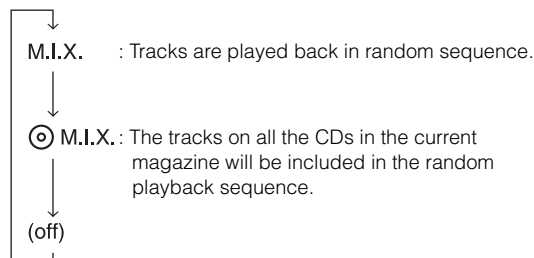

- If **M.I.X.** is set to ON during **RPT** **∞** (**REPEAT ALL**) play in CD changer mode, **M.I.X.** will apply to the current disc only.

MP3/WMA mode :

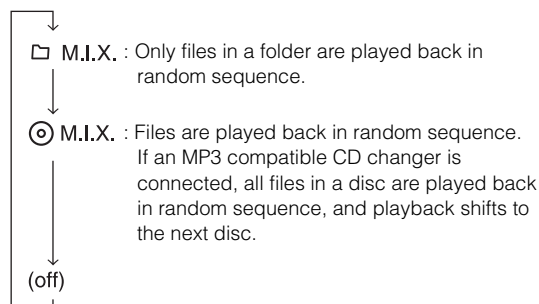

- If a 6-disc CD changer or an MP3 compatible CD changer is connected:
In CD changer mode, press **FUNC.** to illuminate the "**•FUNC•**" indicator, and go to the step above within 10 seconds.
- If a 12-disc CD changer is connected:
In CD changer mode, press **FUNC.** twice to illuminate the "**•FUNC•**" indicator, and go to the step above within 10 seconds.

Searching from CD Text

Tracks can be searched and played using the CD text on the disc. If a disc is not compatible with text, or a disc is in the changer, searches can be made by track number.

- 1 Press **[]** during play.
This will set the search mode.
 - 2 Turn the **Rotary encoder** to select the desired track, then press **MODE**.
This will play the selected track.
- Press and hold **[]** for at least 2 seconds in the search mode to cancel. Or, the search mode will be canceled when an operation has not been performed in 10 seconds.
 - CD text search cannot be made during M.I.X. play.

File/Folder Name Search (concerning MP3/WMA)

You can display and search for the folder and file name while listening to the file currently being played back.

- 1 During MP3/WMA playback, press **[]** to activate the search mode
- 2 Turn the **Rotary encoder** to select Folder Name Search mode or File Name Search mode, then press **[]**.

Folder Name Search mode

- 3 Turn the **Rotary encoder** to select the desired folder.
 - 4 Press **[]** to play back the first file in the selected folder.
- Press and hold **[]** for at least 2 seconds in the search mode to cancel. Or, the search mode will be canceled when an operation has not been performed in 10 seconds.
 - While in Folder Name Search mode, press **[]** to switch to File Name Search mode.
 - While in Folder Name Search mode, press **FUNC.** to return to the selecting search mode.
 - If a disc contains only the root folder, Folder Name Search cannot be made.
 - "NO FILE" is displayed for 2 seconds if the folder that is selected by the Folder Name Search mode contains no files.
 - "ROOT" is displayed for the root folder which does not have folder name.
 - Folder Name search cannot be made during M.I.X. play.

File Name Search mode

- 3 Press **[]** or **[]** to select another Folder.
- 4 Select the desired file by turning the **Rotary encoder**.
- 5 Press **MODE** to play back the selected file.

- Press and hold **[]** for at least 2 seconds in the search mode to cancel. Or, the search mode will be canceled when an operation has not been performed in 10 seconds.
- While in the File Name Search mode, press **FUNC.** to switch to the previous mode (Folder Search mode or the selecting search mode.)
- File Name search cannot be made during M.I.X. play.

Quick Search

You can search for tracks (files).

- 1 Press and hold **[]** for at least 2 seconds in the CD/Changer/MP3/WMA mode to activate Quick Search mode.
 - 2 Turn the **Rotary encoder** to select a desired track (file).
The selected track is played back immediately.
- Press and hold **[]** for at least 2 seconds in the search mode to cancel. Or, the search mode will be canceled when an operation has not been performed in 10 seconds.

About MP3/WMA

CAUTION

Except for private use, duplicating audio data (including MP3/WMA data) or distributing, transferring, or copying it, whether for free or for a fee, without permission of the copyright holder is strictly prohibited by the Copyright Act and by international treaty.

What is MP3?

MP3, whose official name is "MPEG-1 Audio Layer 3," is a compression standard prescribed by the ISO, the International Standardization Organization and MPEG which is a joint activity institution of the IEC.

MP3 files contain compressed audio data. MP3 encoding is capable of compressing audio data at extremely high ratios, reducing the size of music files to as much as one-tenth their original size. This is achieved while still maintaining near CD quality. The MP3 format realizes such high compression ratios by eliminating the sounds that are either inaudible to the human ear or masked by other sounds.

What is WMA?

WMA, or "Windows media™ Audio," is compressed audio data. WMA is similar to MP3 audio data and can achieve CD quality sound with small file sizes.

Method for creating MP3/WMA files

Audio data is compressed by using MP3/WMA specified software. For details on creating MP3/WMA files, refer to the user's manual for that software. MP3/WMA files that can be played back by this device have the file extension "mp3" / "wma". Files with no extension cannot be played back. (WMA ver. 7.1, 8 and 9 are supported)

Supported playback sampling rates and bit rates

MP3

Sampling rates: 48 kHz, 44.1 kHz, 32 kHz, 24 kHz, 22.05 kHz, 16 kHz, 12 kHz, 11.025 kHz, 8 kHz

Bit rates: 8 - 320 kbps

WMA

Sampling rates: 48 kHz, 44.1 kHz, 32 kHz

Bit rates: 48 - 192 kbps

Note that for sampling rates, this device's frame display (Page 15) may not display correctly.

This device may not play back correctly depending on sampling rates.

ID3 tags/WMA tags

This device supports ID3 tag v1 and v2, and WMA tag. If tag data is in an MP3/WMA file, this device can display the title (track title), artist name, and album name ID3 tag/WMA tag data.

This device can only display single-byte alphanumeric characters (up to 30 for ID3 tags and up to 15 for WMA tags) and the underscore. For non-supported characters, "NO SUPPORT" is displayed.

The tag information may not be correctly displayed, depending on the contents.

Producing MP3/WMA discs

MP3/WMA files are prepared, then written to a CD-R or CD-RW using CD-R writing software. A disc can hold up to 510 files/folders (including Root Folders). However, the maximum number of folders is 255.

Media supported

The media that this device can play back are CD-ROMs, CD-Rs, and CD-RWs.

Corresponding File Systems

This device supports discs formatted with ISO9660 Level 1 or Level 2.

Under the ISO9660 standard, there are some restrictions to remember.

The maximum nested folder depth is 8 (including the root directory). The number of folder/file name characters is limited. Valid characters for folder/file names are letters A-Z (all caps), numbers 0-9, and '_' (underscore).

This device also can play back discs in Joliet, Romeo, etc., and other standards that conform to ISO9660. However, sometimes the file names, folder names, etc., are not displayed correctly.

Formats supported

This device supports CD-ROM XA, Mixed Mode CD, Enhanced CD (CD-Extra) and Multi-Session.

This device cannot correctly play back discs recorded with Track At Once or packet writing.

Order of tracks

The unit plays the files in the order that the writing software writes them. Therefore, the playing order may not be the same as the order you input. The playback order of the folders and files is as follows. However, the folder and file playback order differs from the folder no. and file no. indicated on the display.

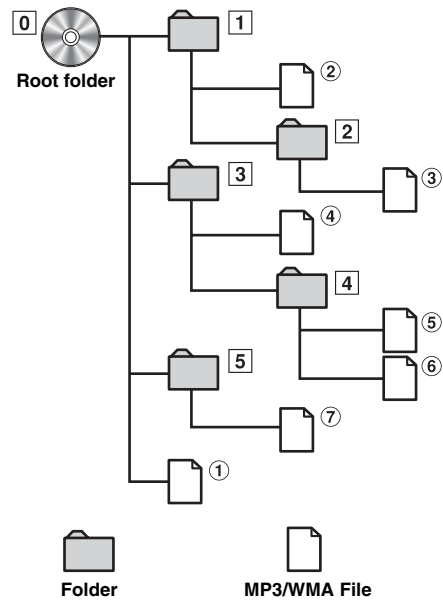

Terminology

Bit rate

This is the "sound" compression rate specified for encoding. The higher the bit rate, the higher the sound quality, but also the larger the files.

Sampling rate

This value shows how many times per second the data is sampled (recorded). For example, music CDs use a sampling rate of 44.1 kHz, so the sound is sampled (recorded) 44,100 times per second. The higher the sampling rate, the higher the sound quality, but also the larger the volume of data.

Encoding

Converting music CDs, WAVE (AIFF) files, and other sound files into the specified audio compression format.

Tag

Song information such as track titles, artist names, album names, etc., written into MP3/WMA files.

MP3: ID3 tag

WMA: WMA tag

Root folder

The root folder is found at the top of the file system. The root folder contains all folders and files.

Sound Setting

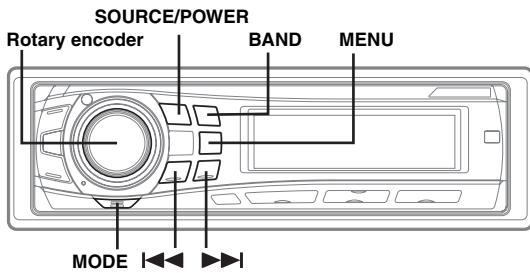

Adjusting Bass/Treble/Balance (Between Left and Right)/Fader (Between Front and Rear)/Defeat

- 1 Press **MODE** repeatedly to choose the desired mode.

Each press changes the modes as follows:

BASS → TREBLE → SUBW* → BALANCE → FADER →
 DEFEAT → VOLUME → BASS

Bass level: -7 ~ +10
 Treble level: -7 ~ +7
 Subwoofer : 0 ~ +15
 Balance : L15 ~ R15
 Fader : R15 ~ F15
 Defeat : ON/OFF
 Volume : 0 ~ 35

- If **MODE** is not pressed within 5 seconds after selecting the **BASS**, **TREBLE**, **BALANCE**, **FADER**, **DEFEAT** or **SUBW** mode, the unit automatically returns to normal mode.
 - * When the subwoofer mode is set to **OFF**, its level cannot be adjusted.
- 2 Turn the **Rotary encoder** until the desired sound is obtained in each mode.
 By setting Defeat ON, previously adjusted settings of **BASS** and **TREBLE** will return to the factory defaults.
 - Depending on the connected devices, some functions and display indications do not work.

Setting the Bass Control

You can change the Bass Frequency emphasis to create your own tonal preference.

- 1 Press **MENU** to select the **BASS ENGINE** mode, then press **MODE**.

BBE → BASS ENGINE → SETUP → RETURN (OFF) → BBE

- 2 Press **◀◀** or **▶▶** to select the **BASS (Bass Center Frequency) control mode**.

BASS ↔ TREBLE

Setting the Bass Center Frequency

- 3-1 Press **SOURCE/POWER** to select the desired bass center frequency.

80Hz → 100Hz → 120Hz → 60Hz → 80Hz

Emphasizes the displayed bass frequency ranges.

Setting the Bass Bandwidth

- 3-2 Press **BAND** to select the desired bass bandwidth.

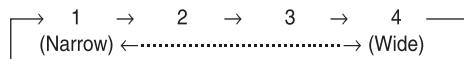

Changes the boosted bass bandwidth to wide or narrow. A wide setting will boost a wide range of frequencies above and below the center frequency. A narrower setting will boost only frequencies near the center frequency.

Setting the Bass Level

- 3-3*1 Turn the **Rotary encoder** to select the desired bass level (-7~+10).

You can emphasize or weaken the bass frequency.

- 4 Press **MENU** to select **RETURN**.

After 2 seconds, the unit returns to normal mode.

Pressing and holding **MENU** for at least 2 seconds will return to normal mode.

- If no operation is performed within 60 seconds, the bass control setting will be turned off automatically.
- The bass level settings will be individually memorized for each source (FM, AM, CD, etc.) until the setting is changed. The bass frequency and bass band width settings adjusted for one source are effective for all other sources (FM, AM, CD, etc.).
- Depending on the connected devices, some functions and display indications do not work. However, Bass Level is still adjustable if an audio processor with the Bass function is connected.
- This function is inoperable when **DEFEAT** is set to **ON**.
- While in the bass adjusting mode, **TREBLE CONTROL** adjusting mode can be recalled by pressing **◀◀** or **▶▶**.

*1 The adjustment can also be made by pressing **MODE**. Refer to "Adjusting Bass/Treble/Balance (Between Left and Right)/Fader (Between Front and Rear)/Defeat" (page 13).

Bass level indicator's display

Bass Level is usually displayed. When BBE is activated, the display changes according to the BBE setting.



Setting the Treble Control

You can change the Treble Frequency emphasis to create your own tonal preference.

- 1 Press **MENU** to select the **BASS ENGINE** mode, then press **MODE**.

BBE → BASS ENGINE → SETUP → RETURN (OFF) → BBE

- 2 Press **◀◀** or **▶▶** to select the **TREBLE (Treble Center Frequency)** control mode.

BASS ↔ TREBLE

Setting the Treble Center Frequency

- 3-1 Press **SOURCE/POWER** to select the desired treble center frequency.

10.0kHz → 12.5kHz → 15.0kHz → 7.5kHz → 10.0kHz

Emphasizes the displayed treble frequency ranges.

Setting the Treble Level

- 3-2*2 Turn the **Rotary encoder** to select the desired treble level (**-7~+7**).

You can emphasize the treble frequency.

- 4 Press **MENU** to select **RETURN**.

After 2 seconds, the unit returns to normal mode.

Pressing and holding **MENU** for at least 2 seconds will return to normal mode.

- If no operation is performed within 60 seconds, the treble control setting will be turned off automatically.
- The treble level settings will be individually memorized for each source (FM, AM, CD, etc.) until the setting is changed. The Treble frequency settings adjusted for one source are effective for all other sources (FM, AM, CD, etc.).
- Depending on the connected devices, some functions and display indications do not work. However, Treble Level is still adjustable if an audio processor with the Treble function is connected.
- This function is inoperable when **DEFEAT** is set to **ON**.
- While in the treble adjusting mode, **BASS CONTROL** adjusting mode can be recalled by pressing **◀◀** or **▶▶**.

*2 The adjustment can also be made by pressing **MODE**. Refer to "Adjusting Bass/Treble/Balance (Between Left and Right)/Fader (Between Front and Rear)/Defeat" (page 13).

Setting the BBE Mode

BBE makes vocals or instruments sound distinct regardless of the music source. The FM radio, CD, and MP3, will be able to reproduce the music clearly even in cars with a lot of road noise.

- 1 Press **SOURCE/POWER** to select the source to which you want to apply BBE.

- 2 Press **MENU** to select BBE mode, then press **MODE**.

BBE → BASS ENGINE → SETUP → RETURN (OFF) → BBE

- 3 Press **▶▶** to set the BBE mode **ON**.

BBE OFF* ←————→ BBE ON
(BBE 1 to 3, EFFECT OFF)

- 4 Turn the **Rotary encoder** to select your preferred BBE level (1 to 3) or **EFFECT OFF**.

- 5 Press **MENU** to select **RETURN**.

After 2 seconds, the unit returns to normal mode.

Pressing and holding **MENU** for at least 2 seconds will return to normal mode.

* To cancel BBE mode for all music sources, press **◀◀** to select **BBE OFF** in step 3.

- Each music source, such as FM radio, CD (included MP3/WMA) can have its own BBE setting.
- This function is inoperable when **DEFEAT** is set to **ON**.
- There is no BBE mode for AM radio.
- When an external audio processor is connected, this setting cannot be made.
- If no operation is performed in 60 seconds, the unit returns to normal mode.

Other Functions

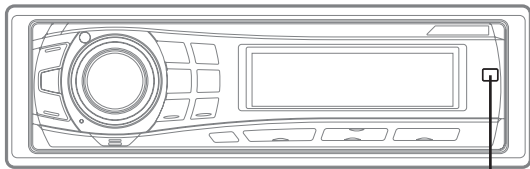

TITLE

Displaying the Text

Text information, such as the disc name and the track name, will be displayed if playing a CD text compatible disc. It is also possible to display the folder name, the file name, and the tag, etc., while playing MP3/WMA files.

Press TITLE.

The display will change every time the button is pressed.

The display in Radio mode:

FREQUENCY → CLOCK → RADIO STATION NAME*^{5/6} → ARTIST NAME*⁵ → ALBUM NAME*⁵ → SONG NAME*⁵ → FREQUENCY

The display in CD mode:

TRACK NO./ELAPSED TIME → TRACK NO./CLOCK → TEXT (DISC NAME)*¹ → TEXT (TRACK NAME)*¹ → TRACK NO./ELAPSED TIME

The display in MP3/WMA mode:

FOLDER NO./FILE NO./ELAPSED TIME → FOLDER NO./FILE NO./CLOCK → FOLDER NAME*³ → FILE NAME → ARTIST NAME*² → ALBUM NAME*² → TRACK NAME*² → FRAME*⁴ → FOLDER NO./FILE NO./ELAPSED TIME

^{*1} Displayed during playback of a disc with CD Text.

If there is no Text (Disc Name or Track Name), "DISC TEXT"/"TRACK TEXT" is displayed. "D TEXT"/"T TEXT" is displayed for changer.

^{*2} ID3 tag/WMA tag

If an MP3/WMA file contains ID3 tag/WMA tag information, the ID3 tag/WMA tag information is displayed (e.g., track name, artist name, and album name). All other tag data is ignored.

If the Scroll Setting (page 17) is set to "SCROLL AUTO," the tag information will scroll automatically.

If there is no tag information, "ARTIST"/"ALBUM"/"SONG" is displayed.

^{*3} "ROOT" is displayed for the root folder which doesn't have folder name.

If there is no folder name or file name, "FOLDER"/"FILE" is displayed.

^{*4} The recording sampling rate and bit rate of the MP3/WMA file are displayed. A WMA file of variable bit rate displays the average bit rate.

^{*5} When an HD radio signal is received, text information such as "RADIO STATION", "ARTIST", etc., is displayed.

If there is no text information, "ARTIST"/"ALBUM"/"SONG"/"STATION" will be displayed.

^{*6} RADIO STATION NAME can be switched between "LONG" and "SHORT" in "HD Radio Station Call Setting" (page 17).

About the indication display

When displaying Text, the following indicators are lit according to the mode.

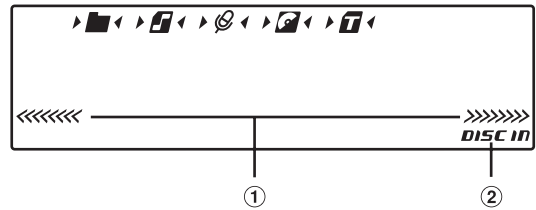

- ① The position of a song being played back is shown lit in the total number of songs shown. The display example is as shown below. Also lights when operation, such as fast forward, etc., is performed.
- ② Lights up when a disc is inserted

Song position display example



- For example, when the 5th of 10 songs in the disc is played back, "<<<< >>>>" is displayed.

Indicator/ Mode	CD Mode	MP3/WMA Mode	SAT RADIO/ HD RADIO Mode	iPod Mode
	—	Folder Name being displayed	—	—
	—	File Name being displayed	—	—
	—	Artist Name being displayed	Artist Name being displayed	Artist Name being displayed
	Text (Disc Name) being displayed	Album Name being displayed	Album Name being displayed (HD Radio only)	Album Name being displayed
	Text (Track Name) being displayed	Track Name being displayed	Song Title/ Channel Name being displayed	Track Name being displayed

About “Text”

Text:

Text compatible CDs contain text information such as the disc name and track name. Such text information is referred to as “text.”

- *Some characters may not be displayed correctly with this device, depending on the character type.*
- *The CD changer must also be CD Text compatible for the Text information to be displayed.*
- *When the Scroll Setting (page 17) is set to “SCROLL MANU,” press and hold **TITLE** for at least 2 seconds to scroll the Text information only once (TEXT DISPLAY, FOLDER NAME DISPLAY, FILE NAME DISPLAY or TAG DISPLAY mode).*
- *“NO SUPPORT” is displayed when the desired text information cannot be displayed on this unit.*
- *The text or tag information may not be correctly displayed, depending on the contents.*

Displaying Time

Press TITLE repeatedly until the time is displayed.

Each press changes the display.

For details, see “Displaying the Text” (page 15).

- *Selecting any tuner or CD function while in the clock priority mode will interrupt the time display momentarily. The function selected will be displayed for about 5 seconds before the time returns to the display.*
- *When the power is off but the ignition key is on, press **TITLE** to display the time.*

SETUP

You can flexibly customize the unit to suit your own preferences and usage. Choose the **SETUP** menu from Sound Customizing, Visual Customizing, etc., to select your desired setting.

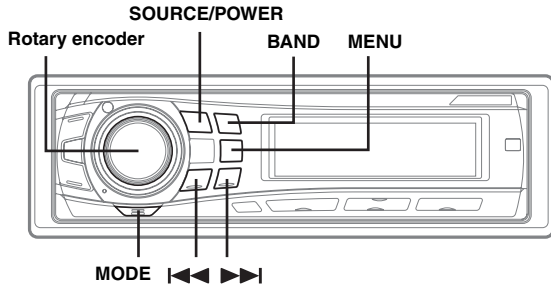

A typical **SETUP** procedure is shown in steps 1 to 4 as follows. See below for further information about each **SETUP** menu.

1 Press **MENU** to select the **SETUP** mode, then press **MODE**.

BBE → BASS ENGINE → SETUP → RETURN (OFF) → BBE

2 Press **◀◀** or **▶▶** to select the desired **SETUP** menu, then press **MODE**.

(e.g. Select SUBWOOFER)

DIMMER ↔ SUBWOOFER ↔ (SUBW SYSTEM)*¹ ↔
PLAY MODE ↔ SCROLL TYPE ↔ TEXT SCROLL ↔
INT MUTE ↔ AUX IN ↔ (AUX NAME)*² ↔ DIGITAL AUX ↔
POWER IC ↔ (CH SELECT)*³ ↔ (XM ADF)*³ ↔
STATION CALL ↔ DEMO ↔ DIMMER

*¹ Displayed only when SUBW is ON.

*² Displayed only when AUX is ON.

*³ When SAT is connected.

For the SAT Radio Setting, refer to "SAT Radio Receiver (Optional)" (page 19).

3 Turn the **Rotary encoder** to change the setting.

(e.g. Select SUBW ON or SUBW OFF.)

4 Press **MENU** to select **RETURN**.

After 2 seconds, the unit returns to normal mode.

Pressing and holding **MENU** for at least 2 seconds will return to normal mode.

Sound Customizing

Subwoofer On and Off

SUBW ON (Initial setting) / SUBW OFF

When the subwoofer is on, perform the steps below to adjust the subwoofer output level.

- 1 In the normal mode, press **MODE** repeatedly to select the SUBW mode.

BASS → TREBLE → SUBW → BALANCE → FADER →
DEFEAT → VOLUME → BASS

- 2 Adjust the level by turning the Rotary encoder.

Setting the Subwoofer System

SUBW SYS1 (Initial setting) / SUBW SYS2

Select either SYS1 or SYS2 for the desired subwoofer effect.

SUBW SYS1: Subwoofer level changes according to the main volume setting.

SUBW SYS2: Subwoofer level change is different from the main volume setting. For example, even at low volume settings, the subwoofer is still audible.

Visual Customizing

Dimmer Control

DIMMER AUTO (Initial setting) / DIMMER MANU

Set the DIMMER control to AUTO to decrease the illumination brightness of the unit with the head lights of the vehicle ON. This mode is useful if you feel the unit's backlighting is too bright at night.

Scroll Type Setting

SCROLL TYPE1 / SCROLL TYPE2 (Initial setting)

Choose from two scrolling methods.

Select the type you prefer.

SCROLL TYPE1: The characters scroll sequentially, appearing from the right side of the display.

SCROLL TYPE2: The characters are displayed one by one, and disappear one by one from the left side of the display after the screen is filled up with the characters.

Scroll Setting (TEXT SCROLL)

SCROLL AUTO / SCROLL MANU (Initial setting)

This CD player can scroll the disc and track names recorded on CD-TEXT discs, as well as text information of MP3/WMA files, folder names, tags, HD Radio and SAT Radio.

SCROLL AUTO: Text information of CD, folder and file names, HD Radio and SAT Radio are scrolled automatically. Also, tag information is automatically scrolled without pressing TITLE in the tag information display mode.

SCROLL MANU: The display is scrolled when a disc is loaded or when a track is changed, etc.

- The unit scrolls CD text names, folder names, file names or tag display.

HD Radio Station Call Setting

SHORT (Initial setting) / LONG

In the HD radio mode, the number of display characters for the HD radio station name can be selected.

SHORT: 7 characters (FM)
4 characters (AM)
LONG: 56 characters

Demonstration

DEMO ON / DEMO OFF (Initial setting)

This unit has a demonstration feature for the display.

- To quit Demo mode, set to DEMO OFF.

MP3/WMA

Playing MP3/WMA Data (PLAY MODE)

CDDA (Initial setting) / CDDA/MP3

This product can playback CDs containing both CD and MP3/WMA data. However, in some situations (some enhanced CDs), playback may be difficult. For these special cases, you can select playback of CD data only. When a disc contains both CD or the MP3/WMA data, playback starts from the CD data portion of the disc.

CDDA:	Only CD data can be played back.
CDDA/MP3:	Both CD data and MP3/WMA file tracks can be played back.

- Perform this setting before inserting a disc. If a disc has already been inserted, perform the setting after you remove the disc. (If you use an MP3 changer, you have to change discs.)

External Device

Turning Mute Mode On/Off (INT MUTE)

MUTE ON (Initial setting) / MUTE OFF

If a device having the interrupt feature is connected, audio will be automatically muted whenever the interrupt signal is received from the device.

Setting the AUX Mode (V-Link)

AUX IN ON / AUX IN OFF (Initial setting)

You can input TV/video sound by connecting an optional Ai-NET/RCA Interface cable (KCA-121B) or Versatile Link Terminal (KCA-410C) to this component.

You can change the AUX name display when AUX IN ON is set. Select the AUX name by pressing **◀◀** or **▶▶**. Then press **MODE**.

If the KCA-410C is connected, it is possible to select two AUX names.

- Via KCA-410C, up to 2 external devices with RCA output can be connected. In this case, press **SOURCE/POWER** to select AUX mode and then press **BAND** to select your desired device.

Setting the External Digital Input (DIGITAL AUX)

D-AUX ON / D-AUX OFF (Initial setting)

When an ALPINE Ai-NET compatible digital audio processor and a DVD player (DVE-5207) not compatible with Ai-NET are connected, set D-AUX to ON to enjoy 5.1-channel surround sound.

- After setting D-AUX to ON, make the setting in "Connecting an Optical Digital Compatible Audio Processor and an Ai-NET Non-Compatible DVD Player."
- Press **SOURCE/POWER**, and select the D-AUX mode, and adjust the volume, etc.
- Depending on the connected audio processor, DVD player sound may continue to be output, even though the source is changed to another one. If this occurs, set the DVD player's power to OFF.

Connecting to an External Amplifier

POWER IC ON (Initial setting) / POWER IC OFF

When an external amplifier is connected, sound quality can be improved by stopping the power supply of the built-in amplifier.

POWER IC OFF : Use this mode when the front and rear pre-amplifier of the unit are used to drive an external amplifier connected to the speakers. In this setting, the head unit's internal amplifier has no output to drive speakers.

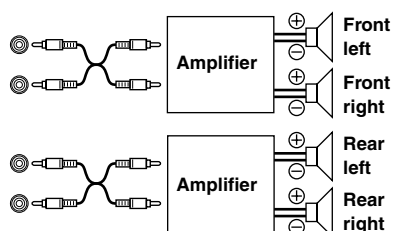

POWER IC ON : The speakers are driven by the built-in amplifier.

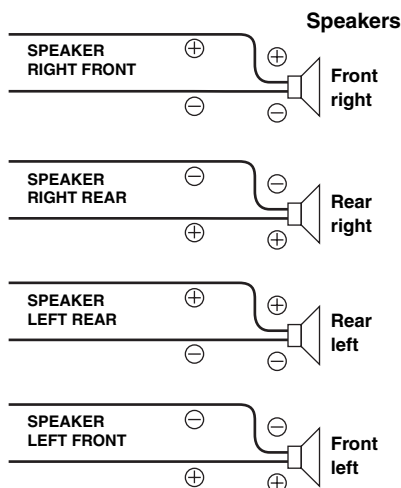

- No sound is produced by the system when the power output is set to OFF.

SAT Radio Receiver (Optional)

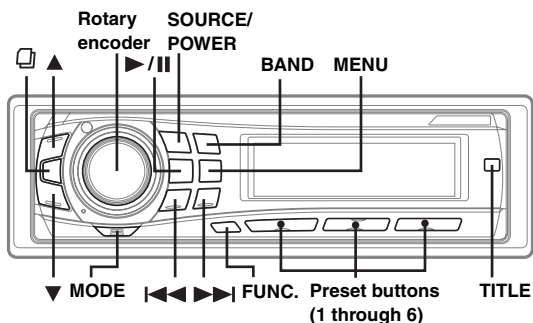

SAT Receiver: XM or SIRIUS Receiver

When an optional XM or SIRIUS Receiver Box is connected via the Ai-NET bus, the following operations may be performed. However, the XM Receiver and SIRIUS Receiver cannot be connected at the same time.

Receiving Channels with the SAT Radio Receiver (Optional)

About SAT Radio

Satellite Radio* is the next generation of audio entertainment, with over 100 digital audio channels. For a small monthly fee, subscribers can hear crystal-clear music, sports, news and talk, coast-to-coast via satellite. For more information, visit XM's website at www.xmradio.com, or SIRIUS' website at www.sirius.com.

To receive SAT Radio, the separately sold XMDirect™ or SIRIUS Satellite Radio Tuner and an appropriate Ai-NET Interface Adapter will be required. For details, consult your nearest Alpine dealer.

* XM and its corresponding logos are trademarks of XM Satellite Radio Inc.

* SIRIUS and its corresponding logos are trademarks of SIRIUS Satellite Radio Inc.

• The SAT Receiver controls on the CDA-9856 are operative only when a SAT Receiver is connected.

1 Press SOURCE/POWER to select SAT Radio mode.

2 Press BAND to select between one of the three SAT Radio Preset Bands.

Each press changes the band:

XM mode:
XM1 → XM2 → XM3 → XM1

SIRIUS mode:
SR1 → SR2 → SR3 → SR1

3 Press ▲ or ▼ to select desired category.

4 Press I◀◀ or ▶▶I to select the desired channel.
Holding down I◀◀ or ▶▶I will change channels continuously.

• When using the optional remote control (RUE-4190, etc.), an SAT Radio Channel can be directly called up with the numeric keypad of the remote control.

- 1 While in XM or SIRIUS Radio mode, enter the Channel number you want to call up with the numeric keypad on the remote control.
- 2 Press ENTER on the remote control within 5 seconds to receive the Channel.
If the channel number is 3 digits, the Channel is automatically received after the channel number is input.

Checking the SAT Radio ID Number

A unique Radio ID number is required to subscribe to SAT Radio programming. Each third party XM or SIRIUS radio comes with this number.

This number is an 8 character (for XM Radio) or 12 character (for SIRIUS Radio) alphanumeric number. It is printed on a label found on the SAT Receiver.

It can also be displayed on the screen of the CDA-9856 in the following way.

XM:

1 While receiving a SAT Radio band, press I◀◀ or ▶▶I to select channel "0" for XM.

The unit alternately displays "CH 00" or "RADIO ID" for 2 seconds, then the ID number for 10 seconds.

While displaying "RADIO ID" as shown above, Demonstration (page 17) become nonfunctional.

2 To cancel the ID number display, set the channel to other than "0."

SIRIUS:

1 While receiving a SAT Radio band, press I◀◀ or ▶▶I to select channel "255" for SIRIUS.

2 Press TITLE until the ID No. appears in the display.

CHANNEL No. → CATEGORY NAME → CHANNEL NAME → ID No. → ID No. → COMP NAME → CLOCK → CHANNEL No.

3 To cancel the ID number display, set the channel to other than "255".

• You cannot use "O," "S," "I," or "F" for the ID Number (XM radio Receiver only).

• You can check the ID number printed on a label on your third party, SAT Radio Receiver package.

Setting the Tuning Method

You can set the tuning method. You can select the received stations in channel No. order or in channel name order (alphabetic order).

To customers using the SIRIUS Tuner Box:

For details about functions, refer to the SIRIUS Tuner Box Owner's Manual.

1 Press MENU to select the SETUP mode, then press MODE.

2 Press I◀◀ or ▶▶I to select "CH SELECT," then press MODE.

3 Turn the **Rotary encoder** to set the tuning method.

CH NO: Set in order of channel No.
ALPHABET: Set in alphabetic order.

4 Press **MENU** to select **RETURN**.

After 2 seconds, the unit returns to normal mode.
Pressing and holding **MENU** for at least 2 seconds will return to normal mode.

- When the setting is completed, switch the channel **DOWN/UP** by pressing the **◀◀** or **▶▶**.

Storing Channel Presets

1 Press **BAND** to select the desired band you want to store.

2 After tuning in the desired channel, press and hold, for at least 2 seconds, any one of the preset buttons (1 through 6) into which you wish to store the channel.

The selected station is stored.

3 Repeat the procedure to store up to 5 other channels onto the same band.

- To use this procedure for other bands, simply select the band desired and repeat the procedure.
- A total of 18 channels can be stored in the preset memory (6 channels for each band; XM1, XM2 and XM3 or SR1, SR2 and SR3).
- If you store a channel in a preset memory which already has a station, the current channel will be cleared and replaced with the new one.

Receiving Stored Channels

1 Press **BAND** to select the desired band.

2 Press the channel preset button that has your desired satellite channel in memory.

Category/Channel Search Function

You can search for programs by Category or Channel No.

1 Press **□** in the XM or SIRIUS mode.

2 Turn the **Rotary encoder** to select **Category Search mode** or **Channel Search mode**, then press **□**.

Category Search mode:

3 Turn the **Rotary encoder** to select the desired **Category**, then press **□**.

4 Turn the **Rotary encoder** to select the desired **Channel No. or Channel Name**, then press **MODE**.

- Search items vary depending on the setting in “Setting the Tuning Method” (page 19).

When “CH NO” is selected: Channel No. Search
When “ALPHABET” is selected: Channel Name Search

- While in **Category Search mode**, press **FUNC.** to return to the selecting search mode.
- The Search mode is canceled if you press and hold **□** for at least 2 seconds, or no operation is performed for 10 seconds in **Category Search mode**.

Channel Search mode:

3 Turn the **Rotary encoder** to select the desired **Channel No. or Channel Name**, then press **MODE**.

- Search items vary depending on the setting in “Setting the Tuning Method” (page 19).

When “CH NO” is selected: Channel No. Search
When “ALPHABET” is selected: Channel Name Search

- While in **Channel Search mode**, press **▲** or **▼** to select another **Category**.
- While in **Channel Search mode**, press **FUNC.** to return to the selecting search mode.
- The Search mode is canceled if you press and hold **□** for at least 2 seconds, or no operation is performed for 10 seconds in **Channel Search mode**.

Quick Search Function

You can search for all Channels.

1 Press and hold **□** for at least 2 seconds in XM or SIRIUS mode to activate **Quick Search mode**.

2 Turn the **Rotary encoder** to select the desired **Channel within 10 seconds**.

The selected Channel is received.

Receiving Weather or Traffic information from SAT Radio

1 Press and hold **▶/||** for at least 2 seconds in the XM or SIRIUS mode.

The received weather or traffic channel is stored.

2 Press and hold **BAND** for at least 2 seconds.

The stored Weather or Traffic channel will be recalled.

3 Press and hold **BAND** for at least 2 seconds.

Returns to normal mode.

- Stored channels can also be recalled by pressing and holding **BAND** for at least 2 seconds, except when in XM or SIRIUS mode.
- The channel excluding the Weather or Traffic information can be stored and recalled.

Changing the Display

Text information, such as the channel name, artist name/feature, and song/program title, is available with each XM or Sirius channel. The unit can display this text information as explained below.

In XM or SIRIUS mode, press **TITLE**.

Each time you press this button, the display changes as shown below.

CHANNEL No. → CATEGORY NAME → CHANNEL NAME →
ARTIST NAME → SONG TITLE → COMPOSER NAME*¹ →
AUXILIARY DATA FIELD*² → CLOCK → CHANNEL No.

*¹ *SIRIUS mode only.*

*² *XM mode only:*

When ADF is turned OFF, this information is not displayed (see "Setting the Auxiliary Data Field Display" on page 21).

- *When the "Scroll Setting (TEXT SCROLL)" (page 17) is set to "SCROLL AUTO," the display scrolls continuously. When the Scroll Setting is set to "SCROLL MANUAL," the display scrolls only once after any function is performed (PRESET, BAND, SEARCH, etc.). Press and hold **TITLE** for more than 2 seconds to scroll the display manually.*
- *"CHANNEL No." and "CLOCK" displays do not scroll.*
- *Depending on the model, the display may differ from the one shown above.*

Setting the Auxiliary Data Field Display

The XM Auxiliary Data Field (ADF) display can be switched on or off. There is no ADF function for the SIRIUS receiver.

- 1 Press **MENU** to select the **SETUP** mode, then press **MODE**.**
- 2 Select "XMADF" by pressing **◀◀** or **▶▶**, then press **MODE**.**
- 3 Select **ON/OFF** by turning the **Rotary encoder**.**
When setting to ON, Auxiliary Data Field is displayed by pressing **TITLE**. (Refer to the "Changing the Display" section page 21.)
- 4 Press **MENU** to select **RETURN**.**
After 2 seconds, the unit returns to normal mode. Pressing and holding **MENU** for at least 2 seconds will return to normal mode.

iPod™ (Optional)

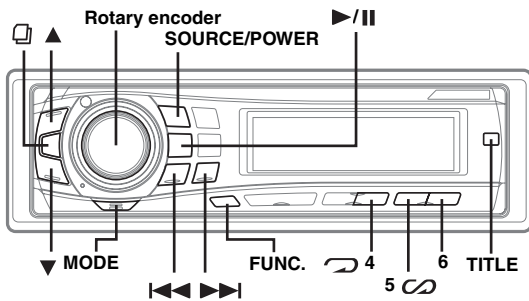

An iPod™, iPod™ mini or iPod™ nano can be connected to the CDA-9856 by using the proprietary ALPINE FULL SPEED™ Connection Cable (KCE-422i). When the CDA-9856 is connected by using the cable, the controls on the iPod™ are not functional.

About iPods™ usable with this unit

The unit can be used with third generation and above iPod™ photo, iPod™ minis or iPod™ nano. iPod™ Shuffle cannot be used, however.

- Touch wheel or scroll wheel type iPods without the dock connector cannot be connected to the unit.
- The unit can be used with the following iPod versions. Correct function of earlier versions cannot be guaranteed.

Third generation iPod: Ver. 2.3
 Forth generation iPod: Ver. 3.0.2
 iPod photo: Ver. 1.0
 iPod mini: Ver. 1.3
 iPod nano: Ver. 1.0

- The unit cannot be used with the software versions earlier than 22nd Feb.2005. For details about "iPod Software Update," refer to the iPod Instruction Manual.

Playback

- 1 Press **SOURCE/POWER** to switch to the iPod mode.

- 2 Press **◀◀** or **▶▶** to select the desired song.

Return to the beginning of the current song:

Press **◀◀**.

Fast backward:

Press and hold **◀◀**.

Advance to the beginning of the next song:

Press **▶▶**.

Fast forward:

Press and hold **▶▶**.

- 3 To pause playback, press **▶/||**.

Pressing **▶/||** again will resume playback.

- If a song is playing on the iPod when it is connected to the CDA-9856, it will continue playing after the connection.

Searching for a desired Song

An iPod can contain hundreds of songs. By keeping these songs organized in playlists, the CDA-9856 can use these to ease song searches.

Searching by Playlist

- 1 Press **□** to activate the search selection mode.
- 2 Turn the **Rotary encoder** to select the **PLAYLIST** search mode, then press **□**.
 PLAYLIST ↔ ARTIST ↔ ALBUM ↔ SONG ↔ PLAYLIST
- 3*1 Turn the **Rotary encoder** to select the desired **Playlist**.
- 4 Press **▶/||**.
 The selected Playlist is played back.

To search for a song in the selected playlist

- 1 After selecting the playlist in step 3*1, press **□** to change to the song search mode of the selected playlist.
 - 2 Turn the **Rotary encoder** to select a song and press **MODE**.
 The selected song is played back.
- While in the search mode, if you press and hold **□** for at least 2 seconds, or no operation is performed for 10 seconds, the search mode is canceled.
 - In the search mode, pressing **FUNC.** will return to the previous mode.
 - All songs in the iPod are played back by selecting the stored "iPod name" in step 3*1.
 - Playlist search cannot be made during M.I.X. play.
 - "NO SONG" will be displayed if there are no songs in the selected playlist in the **PLAYLIST** search mode.

Searching by artist name

- 1 Press **□** to activate the search selection mode.
- 2 Turn the **Rotary encoder** to select the **ARTIST** search mode, then press **□**.
 PLAYLIST ↔ ARTIST ↔ ALBUM ↔ SONG ↔ PLAYLIST
- 3*2 Turn the **Rotary encoder** to select the desired **Artist**.
- 4 Press **▶/||**.
 The selected Artist song is played back.

To search for an album of the selected artist

- 1 After selecting the artist in step 3*2, press **□** to change to the album search mode of the selected artist.
- 2*1 Turn the **Rotary encoder** to select an album.
- 3 Press the **▶/||** to play back all songs of the selected album.

To search for a song of the selected album

- 1 After selecting the album in step 2*¹, press to change to the song search mode of the selected album.
 - 2 Turn the **Rotary encoder** to select a song and press **MODE**.
The selected song is played back.
- While in the search mode, if you press and hold for at least 2 seconds, or no operation is performed for 10 seconds, the search mode is canceled.
 - In the search mode, pressing **FUNC.** will return to the previous mode.
 - If you choose **ALL** in step 3*², and you press /||, all songs in iPod are played back. If you choose **ALL**, and you press , the **ALBUM** search mode for all artists is activated.
 - If you choose **ALL** in step 2*¹, and you press /||, all songs of the selected artist are played back. If you choose **ALL**, and you press , the **SONG** search mode for the selected artist is activated.
 - Artist name search cannot be made during **M.I.X.** play.

Searching by album name

- 1 Press to activate the search selection mode.
- 2 Turn the **Rotary encoder** to select the **ALBUM** search mode, then press .
PLAYLIST ↔ ARTIST ↔ ALBUM ↔ SONG ↔ PLAYLIST
- 3*³ Turn the **Rotary encoder** to select the desired **Album**.
- 4 Press /||.
The selected Album is played back.

To search for a song of the selected album

- 1 After selecting the album in step 3*³, press to change to the song search mode of the selected album.
 - 2 Turn the **Rotary encoder** to select a song and press **MODE**.
The selected song is played back.
- While in the search mode, if you press and hold for at least 2 seconds, or no operation is performed for 10 seconds, the search mode is canceled.
 - In the search mode, pressing **FUNC.** will return to the previous mode.
 - If you choose **ALL** in step 3*³, and you press /||, all songs in the iPod will be played back. If you choose **ALL**, and you press , the **SONG** search mode for all albums is activated.
 - Album name search cannot be made during **M.I.X.** play.

Searching by song name

- 1 Press to activate the search selection mode.
- 2 Turn the **Rotary encoder** to select the **SONG** search mode, then press .
PLAYLIST ↔ ARTIST ↔ ALBUM ↔ SONG ↔ PLAYLIST
- 3 Turn the **Rotary encoder** to select the desired **Song**.

4 Press **MODE**.

The selected song is played back.

- While in the search mode, if you press and hold for at least 2 seconds, or no operation is performed for 10 seconds, the search mode is canceled.
- In the search mode, pressing **FUNC.** will return to the previous mode.
- Song name search cannot be made during **M.I.X.** play.

Select Playlist/Artist/Album

Playlist/Artist/Album can be easily changed.

For example, if you listen to a song from a selected album, the album can be changed.

1 Press or to select the desired **Playlist/Artist/Album**.

- If search selection mode is not activated, only **SONG** is searched, this operation is not possible.
- If an album is selected from an artist search, the album can be searched.
- During shuffle (**M.I.X.**) playback, this operation is not possible.

Quick Search

You can search for songs.

- 1 Press and hold for at least 2 seconds to activate **Quick Search** mode.
- 2 Turn the **Rotary encoder** to select a desired song.
The selected song is played back immediately.

- While in the search mode, if you press and hold for at least 2 seconds, or no operation is performed for 10 seconds, the search mode is canceled.
- If many songs are in iPod, it takes time to search for songs.

Random Play Shuffle (M.I.X.)

The Shuffle function of the iPod is displayed as M.I.X. on the CDA-9856.

Shuffle Albums:

Album shuffle playback plays back all songs in order, then randomly selects the next album. All songs of that album are played back in order, and so on. Any one album is played just once.

Shuffle Songs:

Song shuffle randomly plays back certain selected songs. Any one song plays back just once until all songs have been played back.

1 Press 5 .

The songs will be played back in random sequence.

 M.I.X. → M.I.X. → (off) →  M.I.X.
(Shuffle Albums) (Shuffle Songs)

2 To cancel M.I.X. play, select (off) with the above procedure.

- For details of the search mode, refer to “Searching for a desired Song” (page 22).
- If a song is selected in the album search mode before selecting Shuffle (M.I.X.), the songs will not play back randomly even when Shuffle album is selected.

Shuffle Songs:

Shuffle ALL plays all songs in the iPod randomly. Any one song does not play back again until all songs have been played back.

1 Press 6.

The songs will be played back in random sequence.

M.I.X. → (off) → M.I.X.
(Shuffle ALL)

2 To cancel M.I.X. play, select (off) with the above procedure.

- If Shuffle ALL is selected, the selected ones which played back in the search mode are canceled.

Repeat Play

Only Repeat One is available for the iPod.



Repeat One: A single song is repeatedly played back.

1 Press 4.

The file will be played repeatedly.

RPT → (off) → RPT
(Repeat One)

2 To cancel repeat play, select (off) with the above procedure.

- During repeat playback, no other songs are selectable by pressing  or .

Displaying the Text

You can display the tag information of a song in the iPod.

Press TITLE.

Each press changes the display.

TRACK NO./ELAPSED TIME → TRACK NO./CLOCK →
ARTIST NAME* → ALBUM NAME* → SONG TITLE* →
TRACK NO./ELAPSED TIME

* TAG information

If the Scroll Setting (page 17) is set to “SCROLL AUTO,” the tag information will scroll automatically.

“ARTIST”/“ALBUM”/“SONG” is displayed if there is no tag information.

- When the Scroll Setting (page 17) is set to “SCROLL MANU,” press and hold **TITLE** for at least 2 seconds to scroll the tag information only once.
- Only alphanumeric characters (ASCII) can be displayed.
- If the artist, album or song name, created in iTunes, has too many characters, songs may not be played back when connected to the adapter. Therefore, a maximum of 250 characters is recommended. The maximum number of characters for the head unit is 128 (128 byte).
- Some characters may not be correctly displayed.
- “NO SUPPORT” is displayed when text information is not compatible with the CDA-9856.

Changer (Optional)

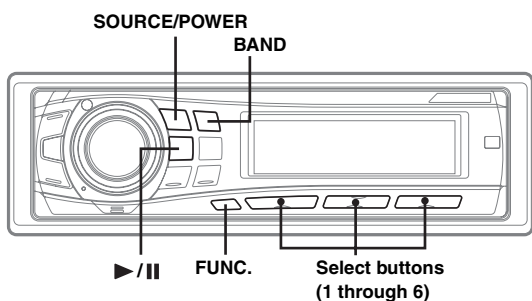

Playing MP3 Files with the CD Changer (Optional)

If you connect a changer compatible with MP3, you can play CD-ROMs, CD-Rs, and CD-RWs containing MP3 files on this unit.

- 1 Press **SOURCE/POWER** to switch to the **MP3 Changer mode**.
- 2 Press any one of the **disc select buttons (1 through 6)** corresponding to one of the discs loaded in the CD Changer.
- 3 To pause playback, press **>/II**. Pressing **>/II** again will resume playback.

- The unit can play discs containing both audio data and MP3 data.
- For operating MP3 with an MP3 compatible CD Changer, refer to "CD/MP3/WMA" pages 9 to 12.

Controlling CD Changer (Optional)

An optional 6-disc or 12-disc CD Changer may be connected to this unit if it is Ai-NET compatible. With a CD Changer connected to the Ai-NET input of this unit, the CD Changer will be controllable from this unit.

Using the KCA-400C (Multi-Changer Switching device) or the KCA-410C (Versatile Link Terminal) multiple changers can be controlled by this unit.

See "Multi-Changer Selection" on page 25 for selecting the CD Changers.

- The controls on this unit for CD Changer operation are operative only when a CD Changer is connected.
- The DVD changer (optional) is controllable from this unit as well as the CD changer.

- 1 Press **SOURCE/POWER** to activate the **CHANGER mode**.

The display shows the disc number and track number.

- The source indicator varies depending on the connected source.
- Press **BAND** to switch the Disc mode in the Changer mode.

- 2 Press the **disc select buttons (1 through 6)** corresponding to one of the discs loaded in the CD Changer.

The selected disc number appears in the display and CD playback starts.

- After selecting the desired disc, you can operate in the same way as for the CD player of this unit.
For details, please see the CD/MP3/WMA section.
- If the "**FUNC.**" indicator is illuminated, the disc select buttons become nonfunctional.

When a 12-disc CD Changer is connected:

To select discs numbered from 1 to 6, the procedure is the same as for the 6-disc CD Changer. To select discs numbered from 7 to 12, first press **FUNC.** to choose the disc select mode (7 to 12). This changes the "D" indicator to "d". Then press the desired **select button**. The select buttons 1 to 6 will represent discs 7 to 12 respectively.

Multi-Changer Selection (Optional)

Alpine's Ai-NET system will support up to 6 CD Changers. When operating two or more changers, the KCA-400C (Multi-Changer Switching device) must be used. If you use 1 Switching device, you can connect up to 4 CD Changers. If you use 2 Switching devices, you can connect up to 6 CD Changers. When using KCA-410C (Versatile Link Terminal), you can connect two changers and two external outputs (AUX).

- 1 Press **SOURCE/POWER** on this unit to activate the **CD Changer mode**.
- 2 Press **BAND** to activate the **CD Changer Selection mode**.
The CD Changer Selection mode remains active for several seconds.
- 3 Press **BAND** until the desired **CD Changer indicator** appears on the display.

- If the selected CD Changer is not connected, the display will show "NO CHGR-No."
- To operate the selected changer, see "CD/MP3/WMA" (pages 9 to 12).
- For further details about the external input (AUX) when using KCA-410C, see "Setting the AUX Mode (V-Link)" on page 18.

Information

In Case of Difficulty

If you encounter a problem, please turn the power off, then on again. If the unit is still not functioning normally, please review the items in the following checklist. This guide will help you isolate the problem if the unit is at fault. Otherwise, make sure the rest of your system is properly connected or consult your authorized Alpine dealer.

Basic

No function or display.

- Vehicle's ignition is off.
 - If connected following instructions, the unit will not operate with the vehicle's ignition off.
- Improper power lead (Red) and battery lead (Yellow) connections.
 - Check power lead and battery lead connections.
- Blown fuse.
 - Check the fuse of the unit; replace with the proper value if necessary.
- Internal micro-computer malfunctioned due to interference noise etc.
 - Press the RESET switch with a ballpoint pen or other pointed article.

Radio

Unable to receive stations.

- No antenna or open connection in cable.
 - Make sure the antenna is properly connected; replace the antenna or cable if necessary.

Unable to tune stations in the seek mode.

- You are in a weak signal area.
 - Make sure the tuner is in the DX mode.
- If the area you are in is a primary signal area, the antenna may not be grounded and connected properly.
 - Check your antenna connections; make sure the antenna is properly grounded at its mounting location.
- The antenna may not be the proper length.
 - Make sure the antenna is fully extended; if broken, replace the antenna with a new one.

Broadcast is noisy.

- The antenna is not the proper length.
 - Extend the antenna fully; replace it if it is broken.
- The antenna is poorly grounded.
 - Make sure the antenna is grounded properly at its mounting location.

CD

CD Player/Changer not functioning.

- Out of operating temperature range +50°C (+120°F) for CD.
 - Allow the vehicle's interior (or trunk) temperature to cool.

CD playback sound is wavering.

- Moisture condensation in the CD Module.
 - Allow enough time for the condensation to evaporate (about 1 hour).

CD insertion not possible.

- A CD is already in the CD player.
 - Eject the CD and remove it.
- The CD is being improperly inserted.
 - Make sure the CD is being inserted following instructions in the CD Player Operation section.

Unable to fast forward or backward the CD.

- The CD has been damaged.
 - Eject the CD and discard it; using a damaged CD in your unit can cause damage to the mechanism.

CD playback sound skips due to vibration.

- Improper mounting of the unit.
 - Securely re-mount the unit.
- The disc is very dirty.
 - Clean the disc.
- The disc has scratches.
 - Change the disc.
- The pick-up lens is dirty.
 - Do not use a Commercial available lens cleaner disc. Consult your nearest Alpine dealer.

CD playback sound skips without vibration.

- The disc is dirty or scratched.
 - Clean the disc; damaged disc should be replaced.

Error displays (built-in CD player only)

- Mechanical error
 - Press \blacktriangle . After the error indication disappears, insert the disc again. If the above-mentioned solution does not solve the problem, consult your nearest Alpine dealer.

CD-R/CD-RW playback not possible

- Close session (finalization) has not been performed.
 - Perform finalization and attempt playback again.

MP3/WMA

MP3 or WMA is not played back.

- Writing error occurred. The CD format is not compatible.
 - Make sure the CD has been written in a supported format. Refer to "About MP3/WMA" (pages 11-12), then rewrite in the format supported by this device.

Audio

The sound is not output from the speakers.

- Unit has no output signal of the internal amplifier.
 - POWER IC is switched to "ON" (page 18).

Indication for CD Player

HI TEMP

- Protective circuit is activated due to high temperature.
 - The indicator will disappear when the temperature returns to within operation range.

NO DISC

- No CD is inserted.
 - Insert a CD.
- Although a disc is inserted, "NO DISC" is displayed and the unit does not start to play or eject the disc.
 - Remove the disc by following these steps:
 - Press the \blacktriangle button again for at least 2 seconds.
 - If the disc still does not eject, consult your Alpine dealer.

ERROR

- Mechanism error.
 - 1) Press the **▲** button and eject the CD.
If not ejecting, consult your Alpine dealer.
 - 2) When the error indication remains after ejecting, press the **▲** button again.
If the error indication still does not turn off after pressing the **▲** button for a few times, consult your Alpine dealer.
 - When "ERROR" is displayed:
*If that the disc cannot be ejected by pressing **▲**, press the RESET switch (refer to page 7) and press **▲** again.*
If the disc still cannot be ejected, consult your Alpine dealer.
-

PROTECT

- A copy-protected WMA file was played back.
 - You can only play back non-copy-protected files.
-

UNSUPPORTED

- The disc is not written in a MP3/WMA supported format.
 - Use a disc written at the MP3/WMA supported format.
-

Indication for CD Changer

HI TEMP

- Protective circuit is activated due to high temperature.
 - The indicator will disappear when the temperature returns to within operation range.
-

ERROR-01

- Malfunction in the CD Changer.
 - Consult your Alpine dealer. Press the magazine eject button and pull out the magazine.
Check the indication. Insert the magazine again.
If the magazine cannot be pulled out, consult your Alpine dealer.
 - Magazine ejection not possible.
 - Press the magazine eject button. If the magazine does not eject, consult your Alpine dealer.
-

ERROR-02

- A disc is left inside the CD Changer.
 - Press the eject button to activate the eject function. When the CD Changer finishes the eject function, insert an empty CD magazine into the CD Changer to receive the disc left inside the CD Changer.
-

NO MAGZN

- No magazine is loaded into the CD Changer.
 - Insert a magazine.
-

NO DISC

- No indicated disc.
 - Choose another disc.
-

Indication for SAT Receiver Mode

ANTENNA

- The XM or SIRIUS antenna is not connected to the XM or SIRIUS radio module.
 - Check whether the XM or SIRIUS antenna cable is attached securely to the XM or SIRIUS radio module.
-

UPDATING

- Radio is being updated with latest encryption code.
 - Wait until encryption code is being updated. Channels 0 and 1 should function normally.
-

NO SIGNAL

(XM mode)

ACQUIRING SIGNAL

(SIRIUS mode)
Scrolling display only once

- XM or SIRIUS signal is too weak at the current location.
 - Wait until the car reaches a location with a stronger signal.
-

LOADING

- Radio is acquiring audio or program information.
 - Wait until the radio has received the information.
-

OFF AIR

(XM mode)

ACQUIRING SIGNAL

(SIRIUS mode)
Scrolling display only once

- The channel currently selected has stopped broadcasting.
 - Select another channel.
-



- The user has selected a channel number that does not exist or is not subscribed to.
 - The unit will revert back to the previously selected channel.
 - There is no artist name/feature, song/program title, or additional information associated with the channel at that time.
 - No action needed.
-

Indication for iPod Mode

NO IPOD

- The iPod is not connected.
 - Make sure the iPod is correctly connected (refer to "Connections").
Make sure the cable is not bent excessively.
- The iPod's battery remains low.
 - Refer to the iPod's documentation and charge the battery.

NO SONG

- There are no songs in the iPod.
 - Download songs to the iPod and connect to the adapter.

ERROR-01

- Communication error
 - Turn the ignition key off, and then set to ON again.
 - Check the display by reconnecting between the iPod and the adapter, using the iPod cable.

ERROR-02

- Caused by the iPod Software Version not being compatible with this unit.
 - Update the iPod Software Version to be compatible with this unit.

Specifications

FM TUNER SECTION

Tuning Range	87.7-107.9 MHz
Mono Usable Sensitivity	9.3 dBf (0.8 μ V/75 ohms)
50 dB Quieting Sensitivity	13.5 dBf (1.3 μ V/75 ohms)
Alternate Channel Selectivity	80 dB
Signal-to-Noise Ratio	65 dB
Stereo Separation	35 dB
Capture Ratio	2.0 dB

AM TUNER SECTION

Tuning Range	530-1,710 kHz
Sensitivity (IEC Standard)	22.5 μ V/27 dB

CD PLAYER SECTION

Frequency Response	5 - 20,000 Hz (\pm 1 dB)
Wow & Flutter (% WRMS)	Below measurable limits
Total Harmonic Distortion	0.008% (at 1 kHz)
Dynamic Range	95 dB (at 1 kHz)
Signal-to-Noise Ratio	105 dB
Channel Separation	85 dB (at 1 kHz)

PICKUP

Wave length	795 nm
Laser power	CLASS I

GENERAL

Power Requirement	14.4 V DC (11-16 V allowable)
Power Output	18 W RMS \times 4*
*Primary amplifier ratings per CEA-2006 Standard	
• Power output: measured at 4 Ohms and \leq 1% THD+N	
• S/N: 80 dBA (reference: 1 W into 4 Ohms)	
Maximum Pre-Output Voltage	2 V/10 k ohms
Bass	+20/-14 dB at 100 Hz
Treble	\pm 14 dB at 10 kHz
Weight	1.6 kg (3 lbs. 8 oz)

CHASSIS SIZE

Width	178 mm (7")
Height	50 mm (2")
Depth	162 mm (6-3/8")

NOSEPIECE SIZE

Width	170 mm (6-11/16")
Height	46 mm (1-13/16")
Depth	24 mm (15/16")

- *Due to continuous product improvement, specifications and design are subject to change without notice.*

Installation and Connections

Before installing or connecting the unit, please read the following and pages 3 and 5 of this manual thoroughly for proper use.

Warning

MAKE THE CORRECT CONNECTIONS.

Failure to make the proper connections may result in fire or product damage.

USE ONLY IN CARS WITH A 12 VOLT NEGATIVE GROUND.

(Check with your dealer if you are not sure.) Failure to do so may result in fire, etc.

BEFORE WIRING, DISCONNECT THE CABLE FROM THE NEGATIVE BATTERY TERMINAL.

Failure to do so may result in electric shock or injury due to electrical shorts.

DO NOT SPLICE INTO ELECTRICAL CABLES.

Never cut away cable insulation to supply power to other equipment. Doing so will exceed the current carrying capacity of the wire and result in fire or electric shock.

DO NOT DAMAGE PIPE OR WIRING WHEN DRILLING HOLES.

When drilling holes in the chassis for installation, take precautions so as not to contact, damage or obstruct pipes, fuel lines, tanks or electrical wiring. Failure to take such precautions may result in fire.

DO NOT USE BOLTS OR NUTS IN THE BRAKE OR STEERING SYSTEMS TO MAKE GROUND CONNECTIONS.

Bolts or nuts used for the brake or steering systems (or any other safety-related system), or tanks should NEVER be used for installations or ground connections. Using such parts could disable control of the vehicle and cause fire etc.

KEEP SMALL OBJECTS SUCH AS BATTERIES OUT OF THE REACH OF CHILDREN.

Swallowing them may result in serious injury. If swallowed, consult a physician immediately.

DO NOT INSTALL IN LOCATIONS WHICH MIGHT HINDER VEHICLE OPERATION, SUCH AS THE STEERING WHEEL OR GEARSHIFT.

Doing so may obstruct forward vision or hamper movement etc. and results in serious accident.

DO NOT ALLOW CABLES TO BECOME ENTANGLED IN SURROUNDING OBJECTS.

Arrange wiring and cables in compliance with the manual to prevent obstructions when driving. Cables or wiring that obstruct or hang up on places such as the steering wheel, gear lever, brake pedals, etc. can be extremely hazardous.

Caution

HAVE THE WIRING AND INSTALLATION DONE BY EXPERTS.

The wiring and installation of this unit requires special technical skill and experience. To ensure safety, always contact the dealer where you purchased this product to have the work done.

USE SPECIFIED ACCESSORY PARTS AND INSTALL THEM SECURELY.

Be sure to use only the specified accessory parts. Use of other than designated parts may damage this unit internally or may not securely install the unit in place. This may cause parts to become loose resulting in hazards or product failure.

ARRANGE THE WIRING SO IT IS NOT CRIMPED OR PINCHED BY A SHARP METAL EDGE.

Route the cables and wiring away from moving parts (like the seat rails) or sharp or pointed edges. This will prevent crimping and damage to the wiring. If wiring passes through a hole in metal, use a rubber grommet to prevent the wire's insulation from being cut by the metal edge of the hole.

DO NOT INSTALL IN LOCATIONS WITH HIGH MOISTURE OR DUST.

Avoid installing the unit in locations with high incidence of moisture or dust. Moisture or dust that penetrates into this unit may result in product failure.

Precautions

- Be sure to disconnect the cable from the (-) battery post before installing your CDA-9856. This will reduce any chance of damage to the unit in case of a short-circuit.
- Be sure to connect the colour coded leads according to the diagram. Incorrect connections may cause the unit to malfunction or damage to the vehicle's electrical system.
- When making connections to the vehicle's electrical system, be aware of the factory installed components (e.g. on-board computer). Do not tap into these leads to provide power for this unit. When connecting the CDA-9856 to the fuse box, make sure the fuse for the intended circuit of the CDA-9856 has the appropriate amperage. Failure to do so may result in damage to the unit and/or the vehicle. When in doubt, consult your Alpine dealer.
- The CDA-9856 uses female RCA-type jacks for connection to other units (e.g. amplifier) having RCA connectors. You may need an adaptor to connect other units. If so, please contact your authorized Alpine dealer for assistance.
- Be sure to connect the speaker (-) leads to the speaker (-) terminal. Never connect left and right channel speaker cables to each other or to the vehicle body.

IMPORTANT

Please record the serial number of your unit in the space provided below and keep it as a permanent record. The serial number or the engraved serial number is located on the bottom of the unit.

SERIAL NUMBER: _____
INSTALLATION DATE: _____
INSTALLATION TECHNICIAN: _____
PLACE OF PURCHASE: _____

Installation

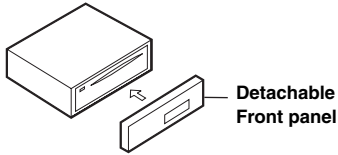

Caution

When you install this unit in your car, do not remove the detachable front panel.
If the detachable front panel is removed during installation, you might press too hard and warp the metal plate that holds it in place.

Accessory List

- Head unit 1
 - Power cable 1
 - Mounting sleeve 1
 - Carrying case 1
 - Bracket key 2
 - Screw (M5x8) 4
 - Owner's Manual 1 set
- The main unit must be mounted within 35 degrees of the horizontal plane, back to front.

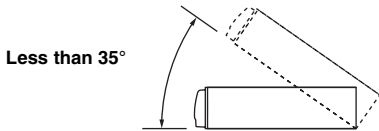

1

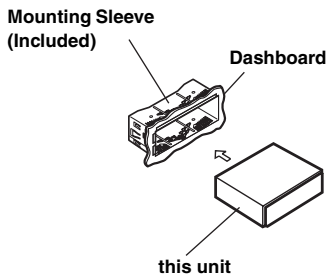

Remove the Detachable Front Panel (refer to page 6). Slide mounting sleeve from main unit (see "Removal" on page 30).

2

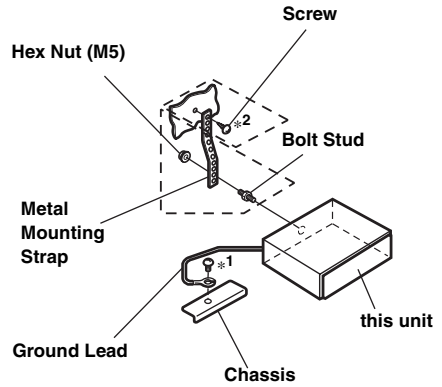

Reinforce the head unit with the metal mounting strap (not supplied). Secure the ground lead of the unit to a clean metal spot using a screw (*1) already attached to the vehicle's chassis.

- For the screw marked "*2", use an appropriate screw for the chosen mounting location.

Connect each input lead coming from an amplifier or equalizer to the corresponding output lead coming from the left rear of the CDA-9856. Connect all other leads of the CDA-9856 according to details described in the CONNECTIONS section.

3

Slide the CDA-9856 into the dashboard until it clicks. This ensures that the unit is properly locked and will not accidentally come out from the dashboard. Install the detachable front panel.

Removal

1. Remove the detachable front panel.
2. Insert the bracket keys into the unit, along the guides on either side. The unit can now be removed from the mounting sleeve.

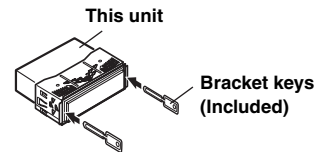

3. Pull the unit out, keeping it unlocked as you do so.

<JAPANESE CAR>

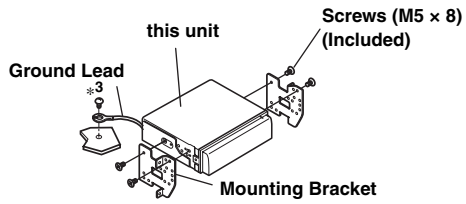
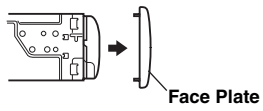

- Secure the ground lead of the unit to a clean metal spot using a screw (*3) already attached to the vehicle's chassis.

Connections

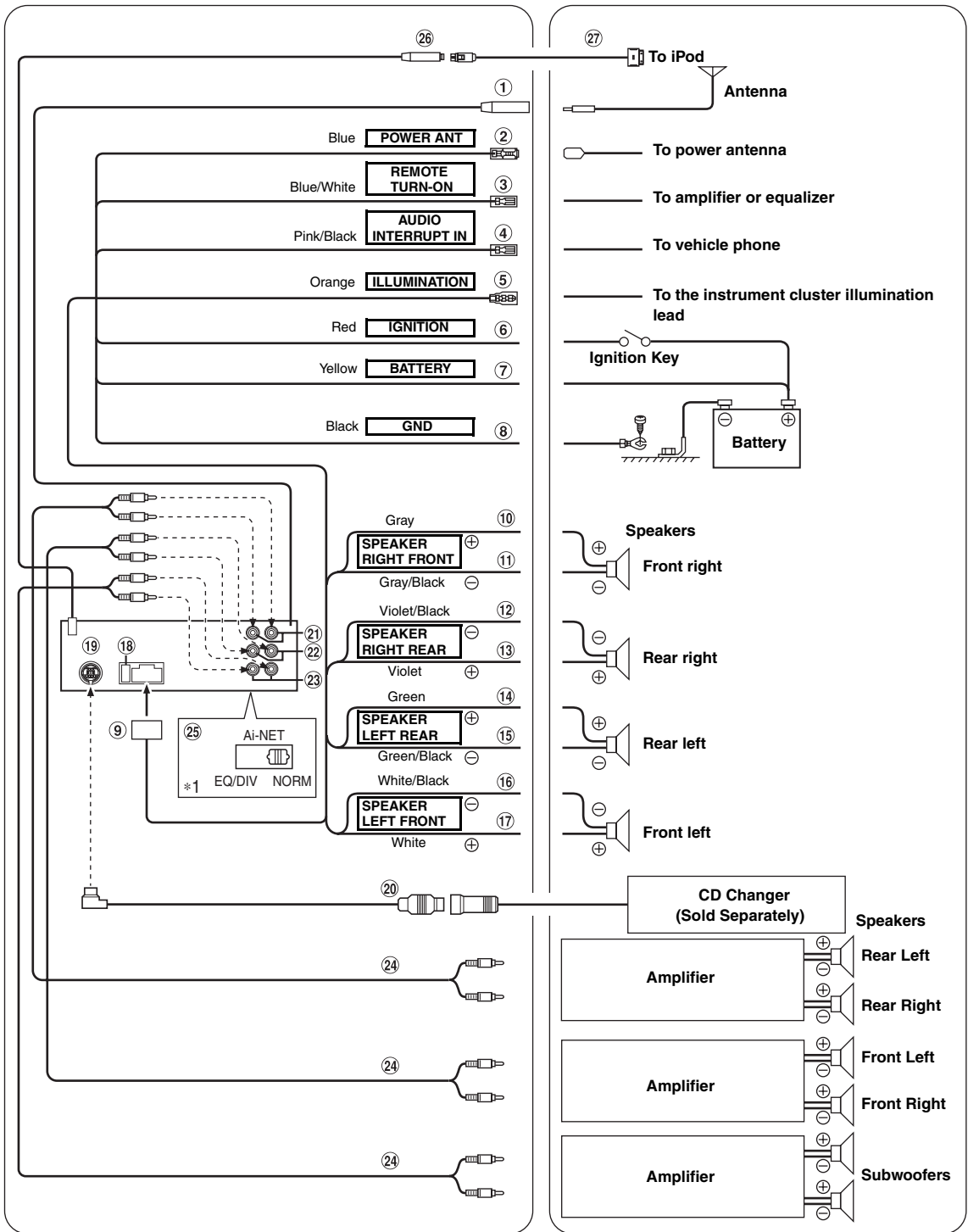

*1 The label is attached on the bottom of the unit.

- ① **Antenna Receptacle**
- ② **Power Antenna Lead (Blue)**
Connect this lead to the +B terminal of your power antenna, if applicable.
 - *This lead should be used only for controlling the vehicle's power antenna. Do not use this lead to turn on an amplifier, or a signal processor, etc.*
- ③ **Remote Turn-On Lead (Blue/White)**
Connect this lead to the remote turn-on lead of your amplifier or signal processor.
- ④ **Audio Interrupt In Lead (Pink/Black)**
- ⑤ **Illumination Lead (Orange)**
This lead may be connected to the vehicle's instrument cluster illumination lead. This will allow the backlighting of the CDA-9856 to dim whenever the vehicle's lights are turned on.
- ⑥ **Switched Power Lead (Ignition) (Red)**
Connect this lead to an open terminal on the vehicle's fuse box or another unused power source which provides (+)12V only when the ignition is turned on or in the accessory position.
- ⑦ **Battery Lead (Yellow)**
Connect this lead to the positive (+) post of the vehicle's battery.
- ⑧ **Ground Lead (Black)**
Connect this lead to a good chassis ground on the vehicle. Make sure the connection is made to bare metal and is securely fastened using the sheet metal screw provided.
- ⑨ **Power Supply Connector**
- ⑩ **Right Front (+) Speaker Output Lead (Gray)**
- ⑪ **Right Front (-) Speaker Output Lead (Gray/Black)**
- ⑫ **Right Rear (-) Speaker Output Lead (Violet/Black)**
- ⑬ **Right Rear (+) Speaker Output Lead (Violet)**
- ⑭ **Left Rear (+) Speaker Output Lead (Green)**
- ⑮ **Left Rear (-) Speaker Output Lead (Green/Black)**
- ⑯ **Left Front (-) Speaker Output Lead (White/Black)**
- ⑰ **Left Front (+) Speaker Output Lead (White)**
- ⑱ **Fuse Holder (10A)**
- ⑲ **Ai-NET Connector**
Connect this to the output or input connector of another device (CD Changer, Equalizer, HD Radio™ TUNER MODULE, etc.) equipped with Ai-NET.
 - *Interface adapter for iPod™ (KCA-420i) is not recommended for use with this product.*
 - *You can input TV/video sound by connecting an optional Ai-NET/ RCA Interface cable (KCA-121B) to this component.*
- ⑳ **Ai-NET Cable (Included with CD Changer)**
- ㉑ **Rear Output RCA Connectors**
RED is right and WHITE is left.
- ㉒ **Front Output RCA Connectors**
RED is right and WHITE is left.
- ㉓ **Subwoofer RCA Connectors**
RED is right and WHITE is left.
- ㉔ **RCA Extension Cable (sold separately)**
- ㉕ **System Switch**
When connecting a processor or divider using Ai-NET, place this switch in the EQ/DIV position. When no device is connected, leave the switch in the NORM position.
 - *Be sure to turn the power off to the unit before changing the switch position.*
- ㉖ **iPod Direct Connector**
Control iPod signals.
Connect this to an iPod, using the (also separately sold) FULL SPEED™ Connection Cable (KCE-422i).
- ㉗ **FULL SPEED™ Connection Cable (KCE-422i) (sold separately)**

To prevent noise/interference in the audio system.

- Locate the unit and route the leads at least 10 cm away from the car harness.
- Keep the battery power leads as far away from other leads as possible.
- Connect the ground lead securely to a bare metal spot (remove any paint, dirt or grease if necessary) of the car chassis.
- If you add an optional noise suppressor, connect it as far away from the unit as possible. Your Alpine dealer carries various noise suppressors, contact them for further information.
- Your Alpine dealer knows best about noise prevention measures so consult your dealer for further information.



NO POSTAGE
NECESSARY
IF MAILED
IN THE
UNITED STATES

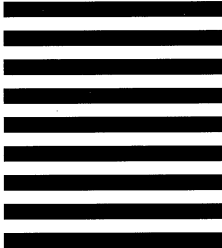

BUSINESS REPLY MAIL
FIRST-CLASS MAIL PERMIT NO. 320 TORRANCE CA

POSTAGE WILL BE PAID BY ADDRESSEE

ATTENTION MARKETING SERVICES
ALPINE ELECTRONICS OF AMERICA INC
PO BOX 2859
TORRANCE CA 90509-9939



Thank you for choosing Alpine! Please register your product with us so we can serve you better.

First name: _____

Last name: _____

Home address: _____
Street address

City _____ State/Prov. _____ Zip Code _____

May we contact you at this address? 1. Yes 2. No

Phone number: () _____

May we contact you at this number? 1. Yes 2. No

E-mail Address: _____

May we contact you by e-mail? 1. Yes 2. No

Gender 1. Male 2. Female

Date of Birth Month: _____ Year: _____

Marital Status 1. Single 2. Married

Which ethnicity best describes yourself:

1. Caucasian 4. Asian
2. Hispanic 5. Other _____
3. African-American

Your highest level of education completed:

1. High School Student
2. High School Graduate
3. 2 Yr. Degree/Some College
4. Completed 4 Yr. College
5. Completed Graduate School

Product purchased

1. Cassette Player 9. Monitor Controller
2. CD Player 10. Video Monitor
3. MD Player 11. Navigation
4. DVD Player 12. Mobile Mayday
5. CD Changer 13. Video Tape Player
6. Amplifier 14. Processor/Equalizer
7. Speaker 15. Security
8. Subwoofer 16. Other _____

Model Number: _____

Serial Number: _____

Date of Purchase: _____
Month: _____ Year: _____

If navigation system, which monitor?

1. Alpine → (Model No.) _____
2. Other → (Brand Name) _____

Purpose of buying this unit?

1. Addition
2. Replacement → *Previous brand replaced?
1. Factory installed
2. Alpine
3. Other _____

Have you purchased Alpine products before?

1. First time 2. Two or more times

When you purchased this Alpine unit, did you compare it with other brands?

1. Yes 2. No

(Brand Name) _____

Which of the following statements best describes you?

1. I usually have more electronic equipment than my friends
2. I am usually one of the first of my friends to buy the newest electronic equipment
3. I usually wait until a product has been out for a while before I purchase it
4. I am usually on of the first of my friends to know about the newest car
5. I usually know more about cars than my friends

Occupation

1. Executive/Managerial 6. Engineering/Technical
2. Secretarial/Clerical 7. Farming/Fishing
3. Sales 8. Retired
4. General Labor 9. Student
5. Professional 10. Other _____

Household Income

1. Less than \$30,000 4. \$70,000 - \$90,000
2. \$30,000 - \$50,000 5. \$90,000 - \$110,000
3. \$50,000 - \$70,000 6. Over \$110,000

Type of vehicle in which this unit is installed.

Make: _____ Model: _____

Purchased Year: _____ Model Year: _____

How was this vehicle purchased?

1. Bought 2. Leased



LIMITED WARRANTY

ALPINE ELECTRONICS OF AMERICA, INC. AND ALPINE OF CANADA INC. ("Alpine"), are dedicated to quality craftsmanship and are pleased to offer this Warranty. We suggest that you read it thoroughly. Should you have any questions, please contact your Dealer or contact Alpine at one of the telephone numbers listed below.

● PRODUCTS COVERED:

This Warranty covers Car Audio Products and Related Accessories ("the product"). Products purchased in the Canada are covered only in the Canada. Products purchased in the U.S.A. are covered only in the U.S.A.

● LENGTH OF WARRANTY:

This Warranty is in effect for one year from the date of the first consumer purchase.

● WHO IS COVERED:

This Warranty only covers the original purchaser of the product, who must reside in the United States, Puerto Rico or Canada.

● WHAT IS COVERED:

This Warranty covers defects in materials or workmanship (parts and labor) in the product.

● WHAT IS NOT COVERED:

This Warranty does not cover the following:

- ① Damage occurring during shipment of the product to Alpine for repair (claims must be presented to the carrier).
- ② Damage caused by accident or abuse, including burned voice coils caused by over-driving the speaker (amplifier level is turned up and driven into distortion or clipping). Speaker mechanical failure (e.g. punctures, tears or rips). Cracked or damaged LCD panels. Dropped or damaged hard drives.
- ③ Damage caused by negligence, misuse, improper operation or failure to follow instructions contained in the Owner's manual.
- ④ Damage caused by act of God, including without limitation, earthquake, fire, flood, storms or other acts of nature.
Any cost or expense related to the removal or reinstallation of the product.
- ⑤ Service performed by an unauthorized person, company or association.
- ⑥ Any product which has the serial number defaced, altered or removed.
- ⑦ Any product which has been adjusted, altered or modified without Alpine's consent.
- ⑧ Any product not distributed by Alpine within the United States, Puerto Rico or Canada.
- ⑨ Any product not purchased from an Authorized Alpine Dealer.

● HOW TO OBTAIN WARRANTY SERVICE:

- ① You are responsible for delivery of the product to an Authorized Alpine Service Center or Alpine for repair and for payment of any initial shipping charges. Alpine will, at its option, repair or replace the product with a new or reconditioned product without charge. If the repairs are covered by the warranty, and if the product was shipped to an Authorized Alpine Service Center or Alpine, Alpine will pay the return shipping charges.
- ② You should provide a detailed description of the problem(s) for which service is required.

- ③ You must supply proof of your purchase of the product.
- ④ You must package the product securely to avoid damage during shipment. To prevent lost packages it is recommended to use a carrier that provides a tracking service.

● HOW WE LIMIT IMPLIED WARRANTIES:

ANY IMPLIED WARRANTIES INCLUDING FITNESS FOR USE AND MERCHANTABILITY ARE LIMITED IN DURATION TO THE PERIOD OF THE EXPRESS WARRANTY SET FORTH ABOVE AND NO PERSON IS AUTHORIZED TO ASSUME FOR ALPINE ANY OTHER LIABILITY IN CONNECTION WITH THE SALE OF THE PRODUCT.

● HOW WE EXCLUDE CERTAIN DAMAGES:

ALPINE EXPRESSLY DISCLAIMS LIABILITY FOR INCIDENTAL AND CONSEQUENTIAL DAMAGES CAUSED BY THE PRODUCT. THE TERM "INCIDENTAL DAMAGES" REFERS TO EXPENSES OF TRANSPORTING THE PRODUCT TO THE ALPINE SERVICE CENTER, LOSS OF THE ORIGINAL PURCHASER'S TIME, LOSS OF THE USE OF THE PRODUCT, BUS FARES, CAR RENTALS OR OTHERS COSTS RELATING TO THE CARE AND CUSTODY OF THE PRODUCT. THE TERM "CONSEQUENTIAL DAMAGES" REFERS TO THE COST OF REPAIRING OR REPLACING OTHER PROPERTY WHICH IS DAMAGED WHEN THIS PRODUCT DOES NOT WORK PROPERLY. THE REMEDIES PROVIDED UNDER THIS WARRANTY ARE EXCLUSIVE AND IN LIEU OF ALL OTHERS.

● HOW STATE/PROVINCIAL LAW RELATES TO THE WARRANTY:

This Warranty gives you specific legal rights, and you may also have other rights which vary from state to state and province to province. In addition, some states/provinces do not allow limitations on how long an implied warranty lasts, and some do not allow the exclusion or limitation of incidental or consequential damages. Accordingly, limitations as to these matters contained herein may not apply to you.

● IN CANADA ONLY:

This Warranty is not valid unless your Alpine car audio product has been installed in your vehicle by an Authorized Installation Center, and this warranty stamped upon installation by the installation center.

● HOW TO CONTACT CUSTOMER SERVICE:

Should the product require service, please call the following number for your nearest Authorized Alpine Service Center.

**CAR AUDIO 1-800-ALPINE-1 (1-800-257-4631)
NAVIGATION 1-888-NAV-HELP (1-888-628-4357)**

Or visit our website at; <http://www.alpine-usa.com>

ALPINE ELECTRONICS OF AMERICA, INC., 19145 Gramercy Place, Torrance, California 90501, U.S.A.

ALPINE ELECTRONICS OF CANADA, INC., 777 Supertest Road, Toronto, Ontario M3J 2M9, Canada

Do not send products to these addresses.

Call the toll free telephone number or visit the website to locate a service center.